





VON DUPRIN®

33A/35A Series Exit Device

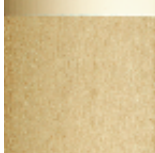

IR Security & Safety
Proven Source. Proven Solutions.™

Finishes*

| Color | US Number | BHMA Number |
|---|-----------|-------------|
|  | US26 | 625 |
|  | US28 | 628 |
|  | US26D | 626 |
|  | US3 | 605 |
|  | US4 | 606 |
|  | US10 | 688 |
|  | 313AN | 710 |
|  | 315AN | — |

Pushpad Options — Knurled —
 Embossed "Push," bronze or stainless steel,
 Braille (Caution-Stairwell), satin stainless steel
 SS – (EMERGENCY EXIT – PUSH TO OPEN AND SOUND ALARM)

* **NOTE:** Durable powder coated finishes available at specific special request. PLEASE CONTACT FACTORY.

Index

| | |
|--|----|
| Introduction | 3 |
| Exit Hardware | |
| • Rim Devices | |
| • 33A/35A Rim Device | 4 |
| • 33A/35A Rim Device Trim | 5 |
| • Surface Mounted Vertical Rod Devices | |
| • 3327A/3527A Surface Mounted Vertical Rod Device | 6 |
| • 3327A/3527A Surface Mounted Vertical Rod Device Trim | 7 |
| • Concealed Vertical Rod Devices | |
| • 3347A/3547A Concealed Vertical Rod Device | 10 |
| • 3347A/3547A Concealed Vertical Rod Device Trim | 11 |
| • 3348A/3548A Concealed Vertical Rod Device | 14 |
| • 3348A/3548A Concealed Vertical Rod Device Trim | 15 |
| Fire Exit Hardware | |
| • Fire Exit Surface Mounted Vertical Rod Devices | |
| • 3327A-F/3527A-F Fire Exit Surface Mounted Vertical Rod Device | 8 |
| • 3327A-F/3527A-F Fire Exit Surface Mounted Vertical Rod Device Trim | 9 |
| • Fire Exit Concealed Vertical Rod Devices | |
| • 3347A-F/3547A-F Fire Exit Concealed Vertical Rod Device | 12 |
| • 3347A-F/3547A-F Fire Exit Concealed Vertical Rod Device Trim | 13 |
| • 3348A-F/3548A-F Fire Exit Concealed Vertical Rod Device | 16 |
| • 3348A-F/3548A-F Fire Exit Concealed Vertical Rod Device Trim | 17 |
| Trim Selection | 18 |
| • Optional Trim | 19 |
| Device Options & Accessories | |
| • ALK Exit Alarm kit | 22 |
| • RX Request to Exit | 22 |
| • LX Latch Bolt Monitoring | 22 |
| • EL Electric Latch Retraction | 23 |
| • SS Signal Switch | 23 |
| • PN Pneumatic | 26 |
| • LBR Less Bottom Rod | 27 |
| • PL Pullman Latch | 27 |
| • RG-27 Vertical Rod and Latch Guard | 27 |
| • Dummy Pushpad | 26 |
| • CD Cylinder Dogging | 26 |
| • CDK, HDK Cylinder Dogging and Hex Key Dogging Kits | 26 |
| • GBK Glass Bead Kit | 27 |
| • Cylinders | 28 |
| • EPT Electric Power Transfer | 25 |
| • Power Supplies | |
| • PS9 | 25 |
| • PS861 | 25 |
| • PS873 | 24 |
| • Operation Options | 22 |
| • Optional Levers | 18 |
| • Optional Strikes | 20 |

Index, pg. 2

| | | |
|-------------------------------|---|--------------|
| Additional Information | • ANSI Grade, Type & Function..... | 21 |
| | • Device Dimensions..... | 21 |
| | • Finishes..... | inside cover |
| | • Fire Label Ratings/Applications..... | 28 |
| | • Handing..... | 28 |
| | • How-To-Order Information..... | 30-31 |
| | • Nomenclature..... | 31 |
| | • Popular Double Door Applications..... | 29 |
| | • Minimum Stile Information..... | 20 |
| | • Trim Changes..... | 30 |

Introduction

The proper selection and application of exit hardware, in addition to safety, are major concerns to all responsible manufacturers. Exit devices are a critical part of a door opening or access system and will provide safe and reliable service when properly applied and maintained. It is the policy of Von Duprin to design and manufacture exit devices to a high standard of quality and reliability in accordance with accepted U.S. domestic and international standards. All 33A and 35A series exit devices are UL listed for Panic Exit or Fire Exit Hardware, and are tested in accordance to ANSI A156.3, 1994, Grade I.

It is intended that the information included in this publication, when properly used, will provide clear and reliable guidelines to the proper general selection and application. However, the scope of the information is necessarily limited.

Unusual operating conditions and environments and other external influences can affect the proper application of the products represented. Modifications of these products will also affect UL listings. It is recommended that whenever an unusual application condition exists, or when any modification of a product is considered, that our engineers review the application.

Application engineering services are available to help ensure proper selection or to review any areas where users of Von Duprin products may have questions.



33A Series features grooved mechanism case.



35A Series features smooth mechanism case.

Von Duprin pushpad exit devices are available in two external surface styles, designated 33A series and 35A series. The two styles are mechanically and dimensionally identical and provide a wide selection of appearance options.

Deadlocking Latchbolt

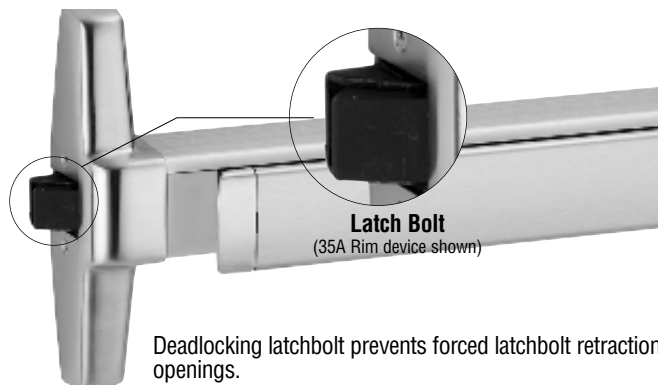

Deadlocking latchbolt prevents forced latchbolt retraction providing higher security for your openings.

The Quiet One®

A fluid dampener decelerates the pushpad on its return stroke and eliminates most noise associated with exit device operations. Furnished on all 33A/35A series exit devices.

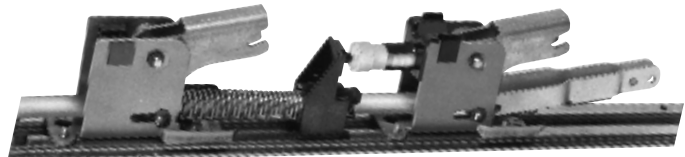

VON DUPRIN® 33A/35A Rim Device



1439 Roller

33A and 35A for all types of single and double doors with mullion, UL listed for Panic Exit Hardware. Devices are ANSI A156.3 – 2001 Grade 1. The 35A has a smooth mechanism case and the 33A has grooved case. The rim device is non-handed except when the SS (Signal Switch) option is used. See opposite page for available outside trim and device functions.

33A/35A fits door stiles as narrow as 1 3/4" (44mm). Newly designed device has a one piece center case cover.



The 33A/35A devices are available in the following finishes; US3, US4, US10, US26, US26D, US28, 313AN and 315AN. See inside cover for finish chips.





Specifications

| | |
|--|---|
| Device Lengths | 3' 2'4" to 3' (711mm to 914 mm) Door Size 4' 2'10" to 4' (864 mm to 1219 mm) Door Size |
| Strikes | 1439 – Dull Black Optional Strikes – see page 20 |
| Dogging Feature | Hex key dogging standard |
| Dogging Options | CD Cylinder Dogging, see page 26 LD Less Dogging see page 26 |
| Electric Options | LX Latchbolt Monitor Switch see page 22 RX Pushpad Monitor Switch see page 22 RX2 Double Pushpad Monitor Switch see page 22 SS Signal Switch see page 23 EL Electric Latch Retraction see page 23 ALK Alarm Exit Kit see page 22 |
| Miscellaneous Options | PN Pneumatic Latch Retraction see page 26 GBK Glass Bead Kit see page 27 |
| Fasteners & Sex Bolts (SNB) | Includes 1 3/4" (44mm) – 2 1/4" (57mm) Wood & Metal Doors #425 SNB furnished standard for end case #325 SNB furnished standard for EO (exit only device) |
| Latch Bolt | Deadlocking, 3/4" (19mm) throw |
| Device Centerline from Finished Floor | 39 13/16" (1011 mm) 39 17/16" (1008 mm) with Mullion |
| Center Case Dimensions | 8 3/16" x 2 13/32" x 1 9/16" (208mm x 62mm x 40mm) |
| Mechanism Case Dimensions | 2 1/4" x 2 1/4" (57mm x 57mm) |
| Projection | Pushbar Neutral – 3 13/16" (97 mm) Pushbar Depressed – 3 1/16" (78 mm) |

See page 31 for How to Order specification

VON DUPRIN® 33A/35A Rim Device Trim

| | Exit Only | Dummy Trim Pull when Dogged | Night Latch Key Retracts Latchbolt | Night Latch Key Retracts Latchbolt Optional Pull Required |
|--------------------------------|------------------|---|---|---|
| | |  |  |  |
| Product Description | 33A-EO 35A-EO | 33A-DT 35A-DT | 33A-NL 35A-NL | 33A-NL-OP 35A-NL-OP |
| Trim Description | — | 386DT | 386NL | 388 |
| Base Size | — | 7 ¹⁵ / ₃₂ "h X 1 ⁵ / ₈ "w (190x41mm) | 7 ¹⁵ / ₃₂ "h X 1 ⁵ / ₈ "w (190x41mm) | 7 ¹ / ₂ "h X 1 ¹¹ / ₁₆ "w (190x43mm) |
| Grip Size | — | 8 ¹ / ₂ "h X 4 ⁵ / ₁₆ "w (216x110mm) | 8 ¹ / ₂ "h X 4 ⁵ / ₁₆ "w (216x110mm) | — |
| Projection | — | 2 ⁷ / ₁₆ " (62mm) | 2 ⁷ / ₁₆ " (62mm) | 1" (25mm) |
| ANSI Function | 01 | 02 | 03 | 03 |
| Cylinder Type | — | — | Rim | Rim |
| Optional Trim (See page 19) | — | x360L-DT x550DT x IVES 8190 | — | X550DT x IVES 8190 10" |

| | Lever Key Locks and Unlocks | Lever Blank Escutcheon Always Operable (No Cylinder) | Thumbturn Key Locks and Unlocks | Thumbturn Always Operable (No Cylinder) |
|--------------------------------|---|---|---|---|
| |  |  |  |  |
| Product Description | 33A-L 35A-L | 33A-L-BE 35A-L-BE | 33A-T 35A-T | 33A-T-BE 35A-T-BE |
| Trim Description | 360L | 360L-BE | 360T | 360T-BE |
| Base Size | 7 ¹ / ₂ "h X 1 ¹¹ / ₁₆ "w X 7 ⁷ / ₈ "d (190x43x22mm) | 7 ¹ / ₂ "h X 1 ¹¹ / ₁₆ "w X 7 ⁷ / ₈ "d (190x43x22mm) | 7 ¹ / ₂ "h X 1 ¹¹ / ₁₆ "w X 7 ⁷ / ₈ "d (190x43x22mm) | 7 ¹ / ₂ "h X 1 ¹¹ / ₁₆ "w X 7 ⁷ / ₈ "d (190x43x22mm) |
| Grip Size | — | — | — | — |
| Projection | 3 (76mm) | 3" (76mm) | 1 ¹³ / ₁₆ " (46mm) | 1 ¹³ / ₁₆ " (46mm) |
| ANSI Function | 08 or 09 Field Selectable | — | 11 or 12 Field Selectable | — |
| Cylinder Type | 1 ¹ / ₄ " Mortise | — | 1 ¹ / ₄ " Mortise | — |
| Optional Trim (See page 19) | — | E360L-BE See Page 18 | — | E360T-BE See Page 18 |

Note: 360L & 360T used on Wood Door require the 33A-WDA cover plate

For optional trims and functions see page 19

VON DUPRIN® 3327A/3527A Surface Mounted Vertical Rod Device

27 Top Latch



27 Bottom Latch



266
Top Strike



248L-4
Bottom Strike
for use with
Threshold



304L
Bottom Strike

3327A and 3527A for all types of single and double doors, UL listed for Panic Exit Hardware. Devices are ANSI A156.3 – 2001 Grade 1. The 3527A has a smooth mechanism case and the 3327A has grooved case. The surface vertical rod device is non-handed except when the SS (Signal Switch) option is used. See opposite page for available outside trim and device functions.

3327A/3527A fits door stiles as narrow as 1 3/4" (44mm). Newly designed device has a one piece center case cover.

The 3327A/3527A devices are available in the following finishes; US3, US4, US10, US26, US26D, US28, 313AN and 315AN. See the inside cover for finish chips.





Specifications





| | |
|--|--|
| Device Lengths | 3' 2'4" to 3' (711mm to 914 mm) Door Size 4' 2'10" to 4' (864 mm to 1219 mm) Door Size |
| Strikes | Top – 266 – Dull Black, Bottom – 248L4 & 304L – Unfinished Optional Strikes – see page 20 |
| Dogging Feature | Hex key dogging standard |
| Dogging Options | CD Cylinder Dogging see page 26 LD Less Dogging see page 26 |
| Electric Options | LX Latchbolt Monitor Switch see page 22 RX Pushpad Monitor Switch see page 22 RX2 Double Pushpad Monitor Switch see page 22 SS Signal Switch see page 23 EL Electric Latch Retraction see page 23 ALK Alarm Exit Kit see page 22 |
| Miscellaneous Options | PN Pneumatic Latch Retraction see page 26 LBR Less Bottom Rod see page 27 GBK Glass Bead Kit see page 27 PL Pullman Latch see page 27 |
| Fasteners & Sex Bolts (SNB) | Includes 1 3/4" (44mm) – 2 1/4" (57mm) Wood & Metal Doors #425 SNB furnished standard for end case #325 SNB furnished standard for EO (exit only device) #325 SNB furnished for top and bottom latches |
| Latch Bolt | Deadlocking Anti-friction Top & Bottom Bolt 5/8" (16mm) throw |
| Device Centerline from Finished Floor | 39 5/8" (1006mm) |
| Door Undercut | 1/4" (7mm) |
| Center Case Dimensions | 8 3/16" x 2 13/32" x 1 9/16" (208mm x 62mm x 40mm) |
| Mechanism Case Dimensions | 2 1/4" x 2 1/4" (57mm x 57mm) |
| Top and Bottom Latch | 4 1/2" x 2 1/8" x 1 1/2" (114mm x 54mm x 38mm) |
| Vertical Rods | 1/2" square tubing, standard rods accommodate 7'(2134mm) door Top rod length is 34 15/16" (887mm) Bottom rod length is 31 1/4"(794mm) Extension rods available 1' (205mm) or 3'(914mm) for doors over 7' One piece top rod available for 8'(2438mm)-10'(3048mm) door |
| Projection | Pushbar Neutral – 3 13/16" (97 mm) Pushbar Depressed – 3 1/16" (78 mm) |

See page 31 for How to Order specification

© 2005 Ingersoll-Rand. May be copied for use with specification submittal.

VON DUPRIN® 3327A/3527A Surface Mounted Vertical Rod Device Trim

| | Exit only | Dummy Trim Pull when dogged | Night Latch Key retracts latchbolt | Night Latch Key retracts latchbolt Optional Pull Required | Thumbturn Key locks & unlocks |
|--------------------------------|----------------------|---|---|---|--|
| | |  |  |  |  |
| Product Description | 3327A-E0 3527A-E0 | 3327A-DT 3527A-DT | 3327A-NL 3527A-NL | 3327A-NL-OP 3527A-NL-OP | 3327A-TL 3527A-TL |
| Trim Description | — | 386DT | 386NL | 388 | 374T x 386 |
| Base Size | — | 7 ¹⁵ / ₃₂ " h X 1 ⁵ / ₈ " w (190x41mm) | 7 ¹⁵ / ₃₂ " h X 1 ⁵ / ₈ " w (190x41mm) | 7 ¹ / ₂ " h X 1 ¹¹ / ₁₆ " w (190x43mm) | 7 ¹ / ₂ " h X 1 ¹¹ / ₁₆ " w X 7 ⁷ / ₈ " d (190x43x22mm) |
| Grip Size | — | 8 ¹ / ₂ " h X 4 ⁵ / ₁₆ " w (216x110mm) | 8 ¹ / ₂ " h X 4 ⁵ / ₁₆ " w (216x110mm) | — | — |
| Projection | — | 2 ⁷ / ₁₆ " (62mm) | 2 ⁷ / ₁₆ " (62mm) | 1" (25mm) | 1 ¹³ / ₁₆ " (46mm) |
| ANSI Function | 01 | 02 | 03 | 03 | 11-12 Field Selectable |
| Cylinder Type | — | — | Rim | Rim | 1 ¹ / ₄ " Mortise |
| Optional Trim (See page 19) | — | x 360L-DT x550 DT x IVES 8190 | — | x550 DT x IVES 8190 10" | x 392-6 |

| | Thumbturn-Blank Escutcheon Always Operable (No Cylinder) | Lever Key Locks & Unlocks | Lever-Blank Escutcheon Always Operable (No Cylinder) | Thumbturn Key Locks & Unlocks | Thumbturn Always Operable (No Cylinder) |
|--------------------------------|--|--|--|--|--|
| |  |  |  |  |  |
| Product Description | 3327A-TL-BE 3527A-TL-BE | 3327A-L 3527A-L | 3327A-L-BE 3527A-L-BE | 3327A-T 3527A-T | 3327A-T-BE 3527A-T-BE |
| Trim Description | 374T-BE x 386 | 360L | 360L-BE | 360T | 360T-BE |
| Base Size | 7 ¹ / ₂ " h X 1 ¹¹ / ₁₆ " w X 7 ⁷ / ₈ " d (190x43x22mm) | 7 ¹ / ₂ " h X 1 ¹¹ / ₁₆ " w X 7 ⁷ / ₈ " d (190x43x22mm) | 7 ¹ / ₂ " h X 1 ¹¹ / ₁₆ " w X 7 ⁷ / ₈ " d (190x43x22mm) | 7 ¹ / ₂ " h X 1 ¹¹ / ₁₆ " w X 7 ⁷ / ₈ " d (190x43x22mm) | 7 ¹ / ₂ " h X 1 ¹¹ / ₁₆ " w X 7 ⁷ / ₈ " d (190x43x22mm) |
| Grip Size | 8 ¹ / ₂ " h X 4 ⁵ / ₁₆ " w (216x110mm) | — | — | — | — |
| Projection | 1 ¹³ / ₁₆ " (46mm) | 3" (76mm) | 3" (76mm) | 1 ¹³ / ₁₆ " (46mm) | 1 ¹³ / ₁₆ " (46mm) |
| ANSI Function | — | 08 or 09 Field Selectable | — | 11 or 12 Field Selectable | — |
| Cylinder Type | — | 1 ¹ / ₄ " Mortise | — | 1 ¹ / ₄ " Mortise | — |
| Optional Trim (See page 19) | x 392-6 | — | E360L-BE See Page 18 | — | E360T-BE See Page 18 |

**Note: 360L & 360T used on Wood Door require the 33A-WDA cover plate
374T used on Wood Door require #10-WDA cover plate.**

For optional trims and functions see page 19

VON DUPRIN® 3327A-F/3527A-F Fire Exit Surface Mounted Vertical Rod Device

27 Top Latch



27 Bottom Latch



299F
Top Strike



304L
Bottom Strike
for use with
Threshold



499F
(LBR only)

3327A-F and 3527A-F for all types of double doors up to 8' x 10' (2438mm x 2540mm), UL listed for Fire Exit Hardware. **See page 28 for detailed information on UL listed fire exit hardware label and door opening size information.** Devices are ANSI A156.3 – 2001 Grade 1. The 3527A-F has a smooth mechanism case and the 3327A-F has grooved case. The surface vertical rod device is non-handed except when the SS (Signal Switch) option is used. See opposite page for available outside trim and device functions.

3327A-F/3527A-F fits door stiles as narrow as 2 3/16" (56 mm). Newly designed device has a one piece center case cover.





The 3327A-F/3527A-F devices are available in the following finishes; US3, US4, US10, US26, US26D, US28, 313AN and 315AN. See the inside cover for finish chips.





Specifications

| | |
|--|--|
| Device Lengths | 3' 2'4" to 3' (711mm to 914 mm) Door Size 4' 2'10" to 4' (864 mm to 1219 mm) Door Size |
| Strikes | Top – 299F(499F LBR) – Dull Black, Bottom – 304L – Unfinished Optional Strikes – see page 20 |
| Dogging Feature | No mechanical Dogging, EL option available |
| Electric Options | LX Latchbolt Monitor Switch see page 22 RX Pushpad Monitor Switch see page 22 RX2 Double Pushpad Monitor Switch see page 22 SS Signal Switch see page 23 EL Electric Latch Retraction see page 23 ALK Alarm Exit Kit see page 22 |
| Miscellaneous Options | PN Pneumatic Latch Retraction see page 26 LBR Less Bottom Rod see page 27 GBK Glass Bead Kit see page 27 |
| Fasteners & Sex Bolts (SNB) | Includes 1 3/4" (44mm) – 2 1/4" (57mm) Wood & Metal Doors #425 SNB furnished standard for end case #325 SNB furnished standard for EO (exit only device) #325 SNB furnished for top and bottom latches |
| Latch Bolt | Deadlocking Anti-friction Top & Bottom Bolt 5/8" (16mm) throw |
| Device Centerline from Finished Floor | 39 5/8" (1006mm) |
| Door Undercut | 1/4" (7mm) |
| Center Case Dimensions | 8 3/16" x 2 13/32" x 1 9/16" (208mm x 62mm x 40mm) |
| Mechanism Case Dimensions | 2 1/4" x 2 1/4" (57mm x 57mm) |
| Top and Bottom Latch | 4 1/2" x 2 1/8" x 1 1/2" (114mm x 54mm x 38mm) |
| Vertical Rods | 1/2" square tubing, standard rods accommodate 7'(2134mm) door Top rod length is 34 15/16" (887mm) Bottom rod length is 31 1/4"(794mm) Extension rods available 1' (205mm) or 3'(914mm) for doors over 7' One piece top rod available for 8'(2438mm)-10'(3048mm) door |
| Projection | Pushbar Neutral – 3 13/16" (97 mm) Pushbar Depressed – 3 1/16" (78 mm) |

See page 31 for How to Order specification

VON DUPRIN® 3327A-F/3527A-F Fire Exit Surface Mounted Vertical Rod Device Trim

| | Exit only | Dummy Trim Pull when dogged (Not recommended for Fire Device) | Night Latch Key retracts latchbolt | Night Latch Key retracts latchbolt Optional Pull Required | Thumbturn Key locks & unlocks |
|--------------------------------|--------------------------|---|---|---|--|
| | |  |  |  |  |
| Product Description | 3327A-EO-F 3527A-EO-F | 3327A-DT-F 3527A-DT-F | 3327A-NL-F 3527A-NL-F | 3327A-NL-OP-F 3527A-NL-OP-F | 3327A-TL-F 3527A-TL-F |
| Trim Description | — | 386DT | 386NL | 388 | 374T x 386 |
| Base Size | — | 7 ¹⁵ / ₃₂ " h X 1 ⁵ / ₈ " w (190x41mm) | 7 ¹⁵ / ₃₂ " h X 1 ⁵ / ₈ " w (190x41mm) | 7 ¹ / ₂ " h X 1 ¹¹ / ₁₆ " (190x43mm) | 7 ¹ / ₂ " h X 1 ¹¹ / ₁₆ " w X 7 ⁷ / ₈ " d (190x43x22mm) |
| Grip Size | — | 8 ¹ / ₂ " h X 4 ⁵ / ₁₆ " w (216x110mm) | 8 ¹ / ₂ " h X 4 ⁵ / ₁₆ " w (216x110mm) | — | 8 ¹ / ₂ " h X 4 ⁵ / ₁₆ " w (216x110mm) |
| Projection | — | 2 ⁷ / ₁₆ " (62mm) | 2 ⁷ / ₁₆ " (62mm) | 1" (25mm) | 1 ¹³ / ₁₆ " (46mm) |
| ANSI Function | 01 | 02 | 03 | 03 | 11-12 Field Selectable |
| Cylinder Type | — | — | Rim | Rim | 1 ¹ / ₄ " Mortise |
| Optional Trim (See page 19) | — | x 360L-DT x550 DT x IVES 8190 | — | x550 DT x IVES 8190 10" | x 392-6 |

| | Thumbturn-Blank Escutcheon Always Operable (No Cylinder) | Lever Key Locks & Unlocks | Lever-Blank Escutcheon Always Operable (No Cylinder) | Thumbturn Key Locks & Unlocks | Thumbturn-Blank Escutcheon Always Operable (No Cylinder) |
|--------------------------------|--|--|--|--|--|
| |  |  |  |  |  |
| Product Description | 3327A-TL-BE-F 3527A-TL-BE-F | 3327A-L-F 3527A-L-F | 3327A-L-BE-F 3527A-L-BE-F | 3327A-T-F 3527A-T-F | 3327A-T-BE-F 3527A-T-BE-F |
| Trim Description | 374T-BE x 386 | 360L | 360L-BE | 360T | 360T-BE |
| Base Size | 7 ¹ / ₂ " h X 1 ¹¹ / ₁₆ " w X 7 ⁷ / ₈ " d (190x43x22mm) | 7 ¹ / ₂ " h X 1 ¹¹ / ₁₆ " w X 7 ⁷ / ₈ " d (190x43x22mm) | 7 ¹ / ₂ " h X 1 ¹¹ / ₁₆ " w X 7 ⁷ / ₈ " d (190x43x22mm) | 7 ¹ / ₂ " h X 1 ¹¹ / ₁₆ " w X 7 ⁷ / ₈ " d (190x43x22mm) | 7 ¹ / ₂ " h X 1 ¹¹ / ₁₆ " w X 7 ⁷ / ₈ " d (190x43x22mm) |
| Grip Size | 8 ¹ / ₂ " h X 4 ⁵ / ₁₆ " w (216x110mm) | — | — | — | — |
| Projection | 2 ⁷ / ₁₆ " (62mm) | 3" (76mm) | 3" (76mm) | 1 ¹³ / ₁₆ " (46mm) | 1 ¹³ / ₁₆ " (46mm) |
| ANSI Function | — | 08 or 09 Field Selectable | — | 11 or 12 Field Selectable | — |
| Cylinder Type | — | 1 ¹ / ₄ " Mortise | — | 1 ¹ / ₄ " Mortise | — |
| Optional Trim (See page 19) | x 392-6 | — | E360L-BE See Page 18 | — | E360T-BE See Page 18 |

**Note: 360L & 360T used on Wood Door require the 33A-WDA cover plate
374T used on Wood Door require #10-WDA cover plate.**

For optional trims and functions see page 19

VON DUPRIN® 3347A/3547A Concealed Vertical Rod Device

47 Top Latch



3347A and 3547A for all types of single and double doors, UL listed for Panic Exit Hardware. Devices are ANSI A156.3 – 2001 Grade 1. The 3547A has a smooth mechanism case and the 3347A has grooved case. The concealed vertical rod device is non-handed except when the SS (Signal Switch) option is used. See opposite page for available outside trim and device functions.

3347A/3547A fits door stiles as narrow as 1 3/4" (44 mm), wood door stiles as narrow as 4" (102mm). Newly designed device has a one piece center case cover.

The 3347A/3547A devices are available in the following finishes; US3, US4, US10, US26, US26D, US28, 313AN and 315AN. See the inside cover for finish chips.



47 Bottom Latch



338
Top Strike



385A
Bottom Strike



283





For use with
wood frame





Specifications

| | |
|--|---|
| Device Lengths | 3' 2'4" to 3' (711mm to 914 mm) Door Size 4' 2'10" to 4' (864 mm to 1219 mm) Door Size |
| Strikes | Top – 338 – Unfinished, Bottom – 385A – Unfinished Optional Strikes – see page 20 |
| Dogging Feature | Hex key dogging standard |
| Dogging Options | CD Cylinder Dogging see page 26 LD Less Dogging see page 26 |
| Electric Options | LX Latchbolt Monitor Switch see page 22 RX Pushpad Monitor Switch see page 22 RX2 Double Pushpad Monitor Switch see page 22 SS Signal Switch see page 23 EL Electric Latch Retraction see page 23 ALK Alarm Exit Kit see page 22 |
| Miscellaneous Options | PN Pneumatic Latch Retraction see page 26 LBR Less Bottom Rod see page 27 GBK Glass Bead Kit see page 27 PL Pullman Latch see page 27 |
| Fasteners & Sex Bolts (SNB) | Includes 1 3/4" (44mm) – 2 1/4" (57mm) Wood & Metal Doors #425 SNB furnished standard for end case #325 SNB furnished standard for EO (exit only device) |
| Latch Bolt | Deadlocking Anti-friction Top & Bottom Bolt 5/8" (16mm) throw |
| Device Centerline from Finished Floor | 39 5/8" (1006mm) Standard, Adjustable from 35 5/8" (905mm) to 49 5/8" (1260mm) |
| Door Undercut | 1/4" (7mm) |
| Center Case Dimensions | 8 3/16" x 2 13/32" x 1 9/16" (208mm x 62mm x 40mm) |
| Mechanism Case Dimensions | 2 1/4" x 2 1/4" (57mm x 57mm) |
| Vertical Rods | Round 2 piece adjustable rods Top rod adjustable from 6'8" (2027mm) to 8'4" (2533mm) Bottom rod adjustable from 35 5/8" (905mm) to 49 5/8" (1260mm) Extension rod kits available for doors over 8'4" (2533mm) |
| Projection | Pushbar Neutral – 3 13/16" (97 mm) Pushbar Depressed – 3 1/16" (78 mm) |

See page 31 for How to Order specification

VON DUPRIN® 3347A/3547A Concealed Vertical Rod Device Trim

| | Exit only | Dummy Trim Pull when dogged | Night Latch Key retracts latchbolt | Night Latch Key retracts latchbolt Optional Pull Required | Thumbturn Key locks & unlocks |
|--------------------------------|----------------------|---|---|---|--|
| | |  |  |  |  |
| Product Description | 3347A-EO 3547A-EO | 3347A-DT 3547A-DT | 3347A-NL 3547A-NL | 3347A-NL-OP 3547A-NL-OP | 3347A-TL 3547A-TL |
| Trim Description | — | 386DT | 386NL | 388 | 376T x 386 |
| Base Size | — | 7 ¹⁵ / ₃₂ " h X 1 ⁵ / ₈ " w (190x41mm) | 7 ¹⁵ / ₃₂ " h X 1 ⁵ / ₈ " w (190x41mm) | 7 ¹ / ₂ " h X 1 ¹¹ / ₁₆ " w (190x43mm) | 7 ¹ / ₂ " h X 1 ¹¹ / ₁₆ " w X 7 ⁷ / ₈ " d (190x43x22mm) |
| Grip Size | — | 8 ¹ / ₂ " h X 4 ⁵ / ₁₆ " w (216x110mm) | 8 ¹ / ₂ " h X 4 ⁵ / ₁₆ " w (216x110mm) | — | 8 ¹ / ₂ " h X 4 ⁵ / ₁₆ " w (216x110mm) |
| Projection | — | 2 ⁷ / ₁₆ " (62mm) | 2 ⁷ / ₁₆ " (62mm) | 1" (25mm) | 1 ¹³ / ₁₆ " (46mm) |
| ANSI Function | 01 | 02 | 03 | 03 | 11-12 Field Selectable |
| Cylinder Type | — | — | Rim | Rim | 1 ¹ / ₄ " Mortise |
| Optional Trim (See page 19) | — | x 360L-DT x 550 DT x IVES 8190 | — | x 550 DT x IVES 8190 10" | x 392-6 |

| | Thumbturn-Blank Escutcheon Always Operable (No Cylinder) | Lever Key Locks & Unlocks | Lever-Blank Escutcheon Always Operable (No Cylinder) | Thumbturn Key Locks & Unlocks | Thumbturn-Blank Escutcheon Always Operable (No Cylinder) |
|--------------------------------|--|--|--|--|--|
| |  |  |  |  |  |
| Product Description | 3347A-TL-BE 3547A-TL-BE | 3347A-L 3547A-L | 3347A-L-BE 3547A-L-BE | 3347A-T 3547A-T | 3347A-T-BE 3547A-T-BE |
| Trim Description | 376T-BE x 386 | 360L | 360L-BE | 360T | 360T-BE |
| Base Size | 7 ¹ / ₂ " h X 1 ¹¹ / ₁₆ " w X 7 ⁷ / ₈ " d (190x43x22mm) | 7 ¹ / ₂ " h X 1 ¹¹ / ₁₆ " w X 7 ⁷ / ₈ " d (190x43x22mm) | 7 ¹ / ₂ " h X 1 ¹¹ / ₁₆ " w X 7 ⁷ / ₈ " d (190x43x22mm) | 7 ¹ / ₂ " h X 1 ¹¹ / ₁₆ " w X 7 ⁷ / ₈ " d (190x43x22mm) | 7 ¹ / ₂ " h X 1 ¹¹ / ₁₆ " w X 7 ⁷ / ₈ " d (190x43x22mm) |
| Grip Size | 8 ¹ / ₂ " h X 4 ⁵ / ₁₆ " w (216x110mm) | — | — | — | — |
| Projection | 2 ⁷ / ₁₆ " (62mm) | 3" (76mm) | 3" (76mm) | 1 ¹³ / ₁₆ " (46mm) | 1 ¹³ / ₁₆ " (46mm) |
| ANSI Function | — | 08 or 09 Field Selectable | — | 11 or 12 Field Selectable | — |
| Cylinder Type | — | 1 ¹ / ₄ " Mortise | — | 1 ¹ / ₄ " Mortise | — |
| Optional Trim (See page 19) | x 392-6 | — | E360L-BE See Page 18 | — | E360T-BE See Page 18 |

**Note: 360L & 360T used on Wood Door require the 33A-WDA cover plate
376T used on Wood Door require #10-WDA cover plate.**

For optional trims and functions see page 19

VON DUPRIN® 3347A-F/3547A-F Fire Exit Concealed Vertical Rod Device

47 Top Latch



3347A-F and 3547A-F for all types of double doors up to 8' x 10' (2438mm x 2540mm), UL listed for Fire Exit Hardware. See page 28 for detailed information on UL listed fire exit hardware label and door opening size information. Devices are ANSI A156.3 – 2001 Grade 1. The 3547A-F has a smooth mechanism case and the 3347A-F has grooved case. The concealed vertical rod device is non-handed except when the SS (Signal Switch) option is used. See opposite page for available outside trim and device functions.

3347A-F/3527A-F fits door stiles as narrow as 3 1/2" (90mm). Newly designed device has a one piece center case cover.

The 3347A-F/3547A-F devices are available in the following finishes; US3, US4, US10, US26, US26D, US28, 313AN and 315AN. See the inside cover for finish chips.

47 Bottom Latch



338
Top Strike



385A
Bottom Strike

Specifications

| | |
|--|---|
| Device Lengths | 3' 2'4" to 3' (711mm to 914 mm) Door Size 4' 2'10" to 4' (864 mm to 1219 mm) Door Size |
| Strikes | Top – 338 – Unfinished, Bottom – 385A – Unfinished Optional Strikes – see page 20 |
| Dogging Feature | No mechanical Dogging, EL option available |
| Electric Options | LX Latchbolt Monitor Switch see page 22 RX Pushpad Monitor Switch see page 22 RX2 Double Pushpad Monitor Switch see page 22 SS Signal Switch see page 23 EL Electric Latch Retraction see page 23 ALK Alarm Exit Kit see page 22 |
| Miscellaneous Options | PN Pneumatic Latch Retraction see page 26 LBR Less Bottom Rod see page 27 GBK Glass Bead Kit see page 27 |
| Fasteners & Sex Bolts (SNB) | Includes 1 3/4" (44mm) – 2 1/4" (57mm) Wood & Metal Doors #425 SNB furnished standard for end case #325 SNB furnished standard for EO (exit only device) |
| Latch Bolt | Deadlocking Anti-friction Top & Bottom Bolt 5/8" (16mm) throw |
| Device Centerline from Finished Floor | 39 5/8" (1006mm) Standard, Adjustable from 35 5/8" (905mm) to 49 5/8" (1260mm) |
| Door Undercut | 1/4" (7mm) |
| Center Case Dimensions | 8 3/16" x 2 13/32" x 1 9/16" (208mm x 62mm x 40mm) |
| Mechanism Case Dimensions | 2 1/4" x 2 1/4" (57mm x 57mm) |
| Vertical Rods | Round 2 piece adjustable rods Top rod adjustable from 6'8" (2027mm) to 8'4" (2533mm) Bottom rod adjustable from 35 5/8" (905mm) to 49 5/8" (1260mm) Extension rod kits available for doors over 8'4" (2533mm) |
| Projection | Pushbar Neutral – 3 13/16" (97 mm) Pushbar Depressed – 3 1/16" (78 mm) |

See page 31 for How to Order specification

VON DUPRIN® 3347A-F/3547A-F Fire Exit Concealed Vertical Rod Device Trim

| | Exit only | Dummy Trim Pull when dogged (Not recommended for Fire Device) | Night Latch Key retracts latchbolt | Night Latch Key retracts latchbolt Optional Pull Required | Thumbturn Key locks & unlocks |
|--------------------------------|--------------------------|---|---|---|--|
| Product Description | 3347A-EO-F 3547A-EO-F | 3347A-DT-F 3547A-DT-F | 3347A-NL-F 3547A-NL-F | 3347A-NL-OP-F 3547A-NL-OP-F | 3347A-TL-F 3547A-TL-F |
| Trim Description | — | 386DT | 386NL | 388 | 376T x 386DT |
| Base Size | — | 7 ¹⁵ / ₃₂ " h X 1 ⁵ / ₈ " w (190x41mm) | 7 ¹⁵ / ₃₂ " h X 1 ⁵ / ₈ " w (190x41mm) | 7 ¹ / ₂ " h X 1 ¹¹ / ₁₆ " w (190x43mm) | 7 ¹ / ₂ " h X 1 ¹¹ / ₁₆ " w X 7 ⁷ / ₈ " d (190x43x22mm) |
| Grip Size | — | 8 ¹ / ₂ " h X 4 ⁵ / ₁₆ " w (216x110mm) | 8 ¹ / ₂ " h X 4 ⁵ / ₁₆ " w (216x110mm) | — | 8 ¹ / ₂ " h X 4 ⁵ / ₁₆ " w (216x110mm) |
| Projection | — | 2 ⁷ / ₁₆ " (62mm) | 2 ⁷ / ₁₆ " (62mm) | 1" (25mm) | 1 ¹³ / ₁₆ " (46mm) |
| ANSI Function | 01 | 02 | 03 | 03 | 11-12 Field Selectable |
| Cylinder Type | — | — | Rim | Rim | 1 ¹ / ₄ " Mortise |
| Optional Trim (See page 19) | — | x 360L-DT x550 DT x IVES 8190 | — | x550 DT x IVES 8190 10" | x 392-6 |

| | Thumbturn-Blank Escutcheon Always Operable (No Cylinder) | Lever Key Locks & Unlocks | Lever-Blank Escutcheon Always Operable (No Cylinder) | Thumbturn Key Locks & Unlocks | Thumbturn-Blank Escutcheon Always Operable (No Cylinder) |
|--------------------------------|--|--|--|--|--|
| Product Description | 3347A-TL-BE-F 3547A-TL-BE-F | 3347A-L-F 3547A-L-F | 3347A-L-BE-F 3547A-L-BE-F | 3347A-T-F 3547A-T-F | 3347A-T-BE-F 3547A-T-BE-F |
| Trim Description | 376T-BE x 386 | 360L | 360L-BE | 360T | 360T-BE |
| Base Size | 7 ¹ / ₂ " h X 1 ¹¹ / ₁₆ " w X 7 ⁷ / ₈ " d (190x43x22mm) | 7 ¹ / ₂ " h X 1 ¹¹ / ₁₆ " w X 7 ⁷ / ₈ " d (190x43x22mm) | 7 ¹ / ₂ " h X 1 ¹¹ / ₁₆ " w X 7 ⁷ / ₈ " d (190x43x22mm) | 7 ¹ / ₂ " h X 1 ¹¹ / ₁₆ " w X 7 ⁷ / ₈ " d (190x43x22mm) | 7 ¹ / ₂ " h X 1 ¹¹ / ₁₆ " w X 7 ⁷ / ₈ " d (190x43x22mm) |
| Grip Size | 8 ¹ / ₂ " h X 4 ⁵ / ₁₆ " w (216x110mm) | — | — | — | — |
| Projection | 2 ⁷ / ₁₆ " (62mm) | 3" (76mm) | 3" (76mm) | 1 ¹³ / ₁₆ " (46mm) | 1 ¹³ / ₁₆ " (46mm) |
| ANSI Function | — | 08 or 09 Field Selectable | — | 11 or 12 Field Selectable | — |
| Cylinder Type | — | 1 ¹ / ₄ " Mortise | — | 1 ¹ / ₄ " Mortise | — |
| Optional Trim (See page 19) | x 392-6 | — | E360L-BE See Page 18 | — | E360T-BE See Page 18 |

**Note: 360L & 360T used on Wood Door require the 33A-WDA cover plate
376T used on Wood Door require #10-WDA cover plate.**

For optional trims and functions see page 19

VON DUPRIN® 3348A/3548A Concealed Vertical Rod Device

48 Top Latch



48 Bottom Latch



338
Top Strike



385A
Bottom Strike

3348A and 3548A for all types of single and double doors, UL listed for Panic Exit Hardware. Devices are ANSI A156.3 – 2001 Grade 1. The 3548A has a smooth mechanism case and the 3348A has grooved case. The concealed vertical rod device is non-handed except when the SS (Signal Switch) option is used. See opposite page for available outside trim and device functions.

3348A/3548A fits door stiles as narrow as 1 3/4" (44 mm). Newly designed device has a one piece center case cover.





The 3348A/3548A devices are available in the following finishes; US3, US4, US10, US26, US26D, US28, 313AN and 315AN. See the inside cover for finish chips.





Specifications

| | |
|--|---|
| Device Lengths | 3' 2'4" to 3' (711mm to 914 mm) Door Size 4' 2'10" to 4' (864 mm to 1219 mm) Door Size |
| Strikes | Top – 338 – Unfinished, Bottom – 385A – Unfinished Optional Strikes – see page 20 |
| Dogging Feature | Hex key dogging standard |
| Dogging Options | CD Cylinder Dogging see page 26 LD Less Dogging see page 26 |
| Electric Options | LX Latchbolt Monitor Switch see page 22 RX Pushpad Monitor Switch see page 22 RX2 Double Pushpad Monitor Switch see page 22 SS Signal Switch see page 23 EL Electric Latch Retraction see page 23 ALK Alarm Exit Kit see page 22 |
| Miscellaneous Options | PN Pneumatic Latch Retraction see page 26 GBK Glass Bead Kit see page 27 |
| Fasteners & Sex Bolts (SNB) | Includes 1 3/4" (44mm) – 2 1/4" (57mm) Wood & Metal Doors #425 SNB furnished standard for end case #325 SNB furnished standard for EO (exit only device) |
| Latch Bolt | Deadlocking Anti-friction Top & Bottom Bolt 3/4" (19mm) throw Deadlocking Anti-friction Top & Bottom Bolt 1 1/2" (38mm) throw |
| Device Centerline from Finished Floor | 39 5/8" (1006mm) Standard, Adjustable from 35 5/8" (905mm) to 49 5/8" (1260mm) |
| Door Undercut | 3/4" (19mm) |
| Center Case Dimensions | 8 9/16" x 2 13/32" x 1 9/16" (208mm x 62mm x 40mm) |
| Mechanism Case Dimensions | 2 1/4" x 2 1/4" (57mm x 57mm) |
| Vertical Rods | Round 2 piece adjustable rods Top rod adjustable from 6'8" (2027mm) to 8'4" (2533mm) Bottom rod adjustable from 35 5/8" (905mm) to 49 5/8" (1260mm) Extension rod kits available for doors over 8'4" (2533mm) |
| Projection | Pushbar Neutral – 3 19/16" (97 mm) Pushbar Depressed – 3 1/16" (78 mm) |

See page 31 for How to Order specification

VON DUPRIN® 3348A/3548A Concealed Vertical Rod Device Trim

| | Exit Only | Dummy Trim Pull when dogged | Night Latch Key retracts latchbolt | Night Latch Key retracts latchbolt Optional Pull Required | Thumbturn Key locks & Unlocks |
|--------------------------------|----------------------|---|---|---|--|
| | |  |  |  |  |
| Product Description | 3348A-EO 3548A-EO | 3348A-DT 3548A-DT | 3348A-NL 3548A-NL | 3348A-NL-OP 3548A-NL-OP | 3348A-TL 3548A-TL |
| Trim Description | — | 386DT | 386NL | 388 | 376T x 386 |
| Base Size | — | 7 ¹⁵ / ₃₂ " h X 1 ⁵ / ₈ " w (190x41mm) | 7 ¹⁵ / ₃₂ " h X 1 ⁵ / ₈ " w (190x41mm) | 7 ¹ / ₂ " h X 1 ¹¹ / ₁₆ " w (190x43mm) | 7 ¹ / ₂ " h X 1 ¹¹ / ₁₆ " w X 7 ⁷ / ₈ " d (190x43x22mm) |
| Grip Size | — | 8 ¹ / ₂ " h X 4 ⁵ / ₁₆ " w (216x110mm) | 8 ¹ / ₂ " h X 4 ⁵ / ₁₆ " w (216x110mm) | — | 8 ¹ / ₂ " h X 4 ⁵ / ₁₆ " w (216x110mm) |
| Projection | — | 2 ⁷ / ₁₆ " (62mm) | 2 ⁷ / ₁₆ " (62mm) | 1" (25mm) | 1 ¹³ / ₁₆ " (46mm) |
| ANSI Function | 01 | 02 | 03 | 03 | 11-12 Field Selectable |
| Cylinder Type | — | — | Rim | Rim | 1 ¹ / ₄ " Mortise |
| Optional Trim (See page 19) | — | x 360L-DT x 550 DT x IVES 8190 | — | x 550 DT x IVES 8190 10" | x 392-6 |

| | Thumbturn-Blank Escutcheon Always Operable (No Cylinder) | Lever Key Locks & Unlocks | Lever-Blank Escutcheon Always Operable (No Cylinder) | Thumbturn Key Locks & Unlocks | Thumbturn-Blank Escutcheon Always Operable (No Cylinder) |
|--------------------------------|--|--|--|--|--|
| |  |  |  |  |  |
| Product Description | 3348A-TL-BE 3548A-TL-BE | 3348A-L 3548A-L | 3348A-L-BE 3548A-L-BE | 3348A-T 3548A-T | 3348A-T-BE 3548A-T-BE |
| Trim Description | 376T-BE x 386 | 360L | 360L-BE | 360T | 360T-BE |
| Base Size | 7 ¹ / ₂ " h X 1 ¹¹ / ₁₆ " w X 7 ⁷ / ₈ " d (190x43x22mm) | 7 ¹ / ₂ " h X 1 ¹¹ / ₁₆ " w X 7 ⁷ / ₈ " d (190x43x22mm) | 7 ¹ / ₂ " h X 1 ¹¹ / ₁₆ " w X 7 ⁷ / ₈ " d (190x43x22mm) | 7 ¹ / ₂ " h X 1 ¹¹ / ₁₆ " w X 7 ⁷ / ₈ " d (190x43x22mm) | 7 ¹ / ₂ " h X 1 ¹¹ / ₁₆ " w X 7 ⁷ / ₈ " d (190x43x22mm) |
| Grip Size | 8 ¹ / ₂ " h X 4 ⁵ / ₁₆ " w (216x110mm) | — | — | — | — |
| Projection | 2 ⁷ / ₁₆ " (62mm) | 3" (76mm) | 3" (76mm) | 1 ¹³ / ₁₆ " (46mm) | 1 ¹³ / ₁₆ " (46mm) |
| ANSI Function | — | 08 or 09 Field Selectable | — | 11 or 12 Field Selectable | — |
| Cylinder Type | — | 1 ¹ / ₄ " Mortise | — | 1 ¹ / ₄ " Mortise | — |
| Optional Trim (See page 19) | x 392-6 | — | E360L-BE See Page 18 | — | E360T-BE See Page 18 |

**Note: 360L & 360T used on Wood Door require the 33A-WDA cover plate
376T used on Wood Door require #10-WDA cover plate.**

For optional trims and functions see page 19

VON DUPRIN® 3348A-F/3548A-F Fire Exit Concealed Vertical Rod Device

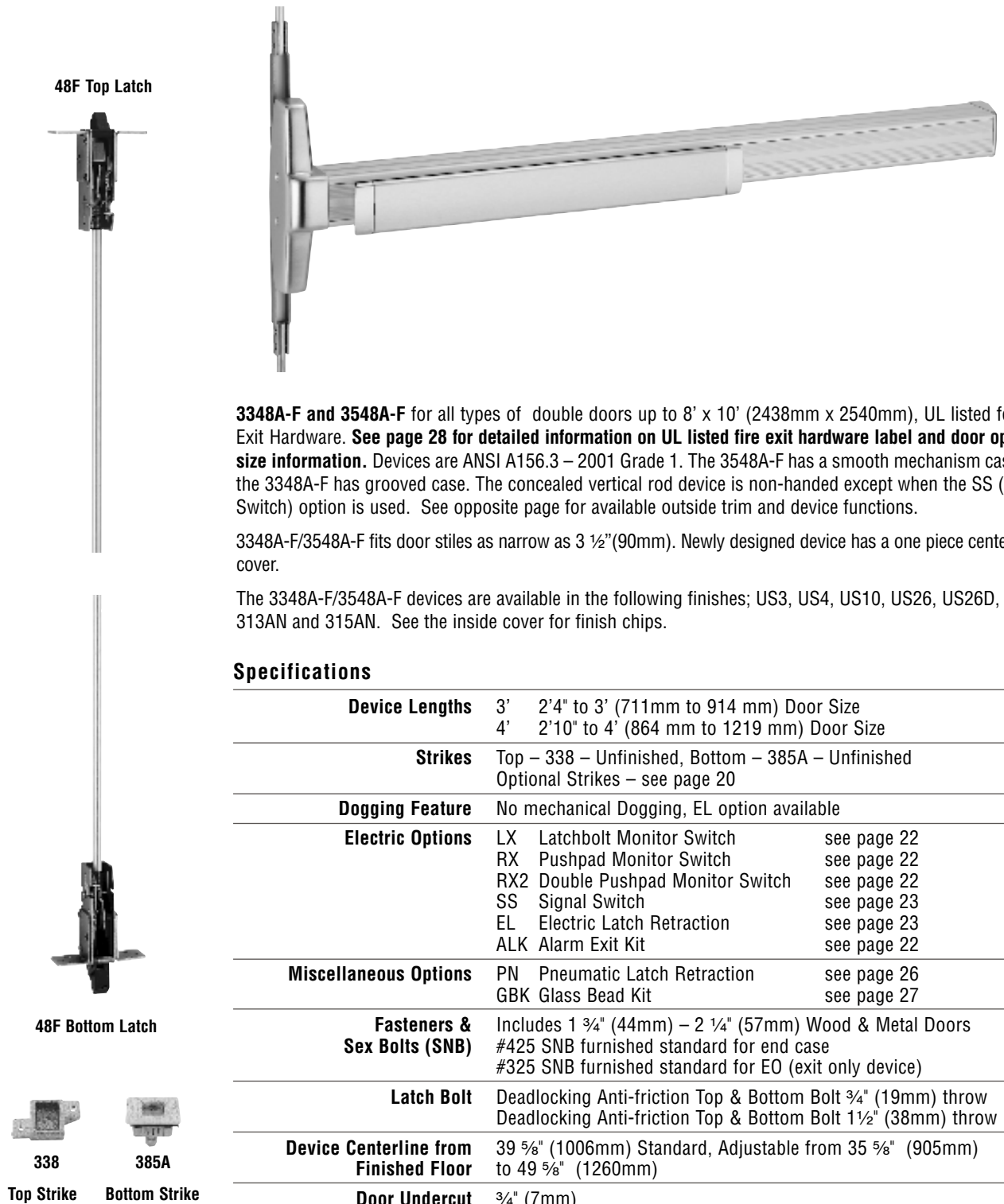

3348A-F and 3548A-F for all types of double doors up to 8' x 10' (2438mm x 2540mm), UL listed for Fire Exit Hardware. **See page 28 for detailed information on UL listed fire exit hardware label and door opening size information.** Devices are ANSI A156.3 – 2001 Grade 1. The 3548A-F has a smooth mechanism case and the 3348A-F has grooved case. The concealed vertical rod device is non-handed except when the SS (Signal Switch) option is used. See opposite page for available outside trim and device functions.

3348A-F/3548A-F fits door stiles as narrow as 3 1/2" (90mm). Newly designed device has a one piece center case cover.





The 3348A-F/3548A-F devices are available in the following finishes; US3, US4, US10, US26, US26D, US28, 313AN and 315AN. See the inside cover for finish chips.





Specifications

| | |
|--|---|
| Device Lengths | 3' 2'4" to 3' (711mm to 914 mm) Door Size 4' 2'10" to 4' (864 mm to 1219 mm) Door Size |
| Strikes | Top – 338 – Unfinished, Bottom – 385A – Unfinished Optional Strikes – see page 20 |
| Dogging Feature | No mechanical Dogging, EL option available |
| Electric Options | LX Latchbolt Monitor Switch see page 22 RX Pushpad Monitor Switch see page 22 RX2 Double Pushpad Monitor Switch see page 22 SS Signal Switch see page 23 EL Electric Latch Retraction see page 23 ALK Alarm Exit Kit see page 22 |
| Miscellaneous Options | PN Pneumatic Latch Retraction see page 26 GBK Glass Bead Kit see page 27 |
| Fasteners & Sex Bolts (SNB) | Includes 1 3/4" (44mm) – 2 1/4" (57mm) Wood & Metal Doors #425 SNB furnished standard for end case #325 SNB furnished standard for EO (exit only device) |
| Latch Bolt | Deadlocking Anti-friction Top & Bottom Bolt 3/4" (19mm) throw Deadlocking Anti-friction Top & Bottom Bolt 1 1/2" (38mm) throw |
| Device Centerline from Finished Floor | 39 5/8" (1006mm) Standard, Adjustable from 35 5/8" (905mm) to 49 5/8" (1260mm) |
| Door Undercut | 3/4" (7mm) |
| Center Case Dimensions | 8 3/16" x 2 13/32" x 1 9/16" (208mm x 62mm x 40mm) |
| Mechanism Case Dimensions | 2 1/4" x 2 1/4" (57mm x 57mm) |
| Vertical Rods | Round 2 piece adjustable rods Top rod adjustable from 6'8" (2027mm) to 8'4" (2533mm) Bottom rod adjustable from 35 5/8" (905mm) to 49 5/8" (1260mm) Extension rod kits available for doors over 8'4" (2533mm) |
| Projection | Pushbar Neutral – 3 13/16" (97 mm) Pushbar Depressed – 3 1/16" (78 mm) |

See page 31 for How to Order specification

VON DUPRIN® 3348A-F/3548A-F Fire Exit Concealed Vertical Rod Device Trim

| | Exit only | Dummy Trim Pull when dogged (Not recommended for Fire Device) | Night Latch Key retracts latchbolt | Night Latch Key retracts latchbolt Optional Pull Required | Thumbturn Key locks & Unlocks |
|--------------------------------|--------------------------|---|---|---|--|
| | |  |  |  |  |
| Product Description | 3348A-EO-F 3548A-EO-F | 3348A-DT-F 3548A-DT-F | 3348A-NL-F 3548A-NL-F | 3348A-NL-OP-F 3548A-NL-OP-F | 3348A-TL-F 3548A-TL-F |
| Trim Description | — | 386DT | 386NL | 388 | 376T x 386 |
| Base Size | — | 7 ¹⁵ / ₃₂ " h X 1 ⁵ / ₈ " w (190x41mm) | 7 ¹⁵ / ₃₂ " h X 1 ⁵ / ₈ " w (190x41mm) | 7 ¹ / ₂ " h X 1 ¹¹ / ₁₆ " w (190x43mm) | 7 ¹ / ₂ " h X 1 ¹¹ / ₁₆ " w X 7 ⁷ / ₈ " d (190x43x22mm) |
| Grip Size | — | 8 ¹ / ₂ " h X 4 ⁵ / ₁₆ " w (216x110mm) | 8 ¹ / ₂ " h X 4 ⁵ / ₁₆ " w (216x110mm) | — | 8 ¹ / ₂ " h X 4 ⁵ / ₁₆ " w (216x110mm) |
| Projection | — | 2 ⁷ / ₁₆ " (62mm) | 2 ⁷ / ₁₆ " (62mm) | 1" (25mm) | 1 ¹³ / ₁₆ " (46mm) |
| ANSI Function | 01 | 02 | 03 | 03 | 11-12 Field Selectable |
| Cylinder Type | — | — | Rim | Rim | 1 ¹ / ₄ " Mortise |
| Optional Trim (See page 19) | — | x 360L-DT x550 DT x IVES 8190 | — | x550 DT x IVES 8190 10" | x 392-6 |

| | Thumbturn-Blank Escutcheon Always Operable (No Cylinder) | Lever Key Locks & Unlocks | Lever-Blank Escutcheon Always Operable (No Cylinder) | Thumbturn Key Locks & Unlocks | Thumbturn-Blank Escutcheon Always Operable (No Cylinder) |
|--------------------------------|--|--|--|--|--|
| |  |  |  |  |  |
| Product Description | 3348A-TL-BE-F 3548A-TL-BE-F | 3348A-L-F 3548A-L-F | 3348A-L-BE-F 3548A-L-BE-F | 3348A-T-F 3548A-T-F | 3348A-T-BE-F 3548A-T-BE-F |
| Trim Description | 376T-BE x 386 | 360L | 360L-BE | 360T | 360T-BE |
| Base Size | 7 ¹ / ₂ " h X 1 ¹¹ / ₁₆ " w X 7 ⁷ / ₈ " d (190x43x22mm) | 7 ¹ / ₂ " h X 1 ¹¹ / ₁₆ " w X 7 ⁷ / ₈ " d (190x43x22mm) | 7 ¹ / ₂ " h X 1 ¹¹ / ₁₆ " w X 7 ⁷ / ₈ " d (190x43x22mm) | 7 ¹ / ₂ " h X 1 ¹¹ / ₁₆ " w X 7 ⁷ / ₈ " d (190x43x22mm) | 7 ¹ / ₂ " h X 1 ¹¹ / ₁₆ " w X 7 ⁷ / ₈ " d (190x43x22mm) |
| Grip Size | 8 ¹ / ₂ " h X 4 ⁵ / ₁₆ " w (216x110mm) | — | — | — | — |
| Projection | 2 ⁷ / ₁₆ " (62mm) | 3" (76mm) | 3" (76mm) | 1 ¹³ / ₁₆ " (46mm) | 1 ¹³ / ₁₆ " (46mm) |
| ANSI Function | — | 08 or 09 Field Selectable | — | 11 or 12 Field Selectable | — |
| Cylinder Type | — | 1 ¹ / ₄ " Mortise | — | 1 ¹ / ₄ " Mortise | — |
| Optional Trim (See page 19) | x 392-6 | — | E360L-BE See Page 18 | — | E360T-BE See Page 18 |

**Note: 360L & 360T used on Wood Door require the 33A-WDA cover plate
376T used on Wood Door require #10-WDA cover plate.**

For optional trims and functions see page 19

Lever Design Options

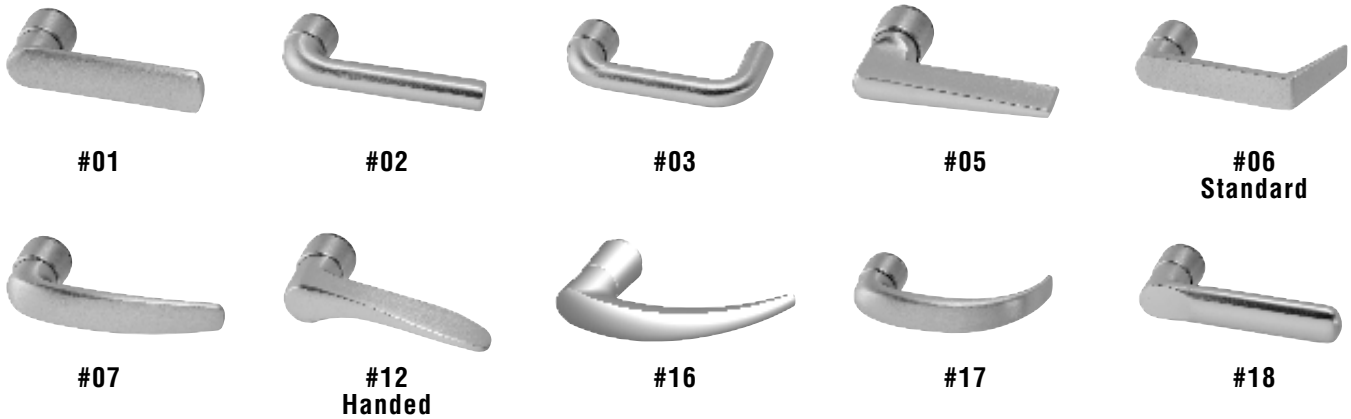

To order, specify:

1. Use suffix lever number, example 3327A-L x 03.

Operation Options — 360 Series Lever and Thumbturn



Standard operation, key locks and unlocks lever or thumbturn. Use dogged* mortise cylinder straight cam. (Classroom)

Night latch operation, lever or thumbturn retracts latch for NL function. Use undogged* mortise cylinder straight cam. (Storeroom)

Blank escutcheon, lever or thumbturn always active. Use BE suffix, i.e., 360L-BE. (Passage)

Blank Escutcheon, rigid lever. Use DT suffix, i.e., 360L-DT.

Operation Options — 374T/376T Series Thumbturn Control



Standard operation, key locks and unlocks thumbturn. Optional operation, key unlocks thumbturn, re-locks when key is removed. This operation is created by changing the cylinder plate included with control. Use 1¼" mortise cylinder with a straight cam. Schlage cam reference B502-191.

* See page 28 for mortise cylinder information.

E360 Series Controls

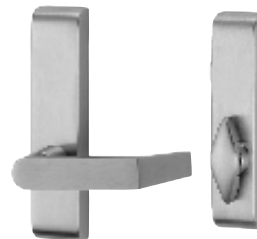

Options:





- Available in all device finishes
- 24VDC Solenoid.....(.5 amp draw)
- Fail Safe (FS) or Fail Secure (FSE)
- Blank Escutcheon (BE) only





The E360 series controls provide the same choice of lever or thumbturn control of the 33A/35A series exit device series. Additionally, these trims have the advantage of being electrically controllable by a remote switching device, an access control system or automatic fire alarm system. The trim operates with a rotary solenoid that controls the locking cam the same way the standard cylinder works. These trims are available as -BE (Blank Escutcheon) function only. These trims are designed for use with the rim, surface vertical and concealed vertical 33A/35A device series.

To order, specify:

1. FSE or FS
2. Handing (Lever control)
3. EPT-2 Power Transfer or Electric Hinge will be used

VON DUPRIN® 33A/35A Optional Trim

| | Lever Key Locks & Unlocks  | Night Latch Key Retracts Latchbolt  | Night Latch Key Retracts Latchbolt  | Thumbturn Key Locks & Unlocks  | Thumbturn Key Locks & Unlocks  |
|------------------|--|---|---|--|--|
| Trim Description | 360L-DT | 388 x 550DT | 388 x IVES 8190 10" | 360T x 550DT | 360T x IVES 8190 10" |
| Base Size | 7 1/2" h X 1 11/16" w X 7/8" d (190x43x22mm) | 7 1/2" h X 1 11/16" w (190x43mm) | 7 1/2" h X 1 11/16" w (190x43mm) | 7 1/2" h X 1 11/16" w X 7/8" d (190x43x22mm) | 7 1/2" h X 1 11/16" w X 7/8" d (190x43x22mm) |
| Grip Size | — | — | — | — | — |
| Projection | 3" (76mm) | 1" (25mm) | 1" (25mm) | 1 13/16" (46mm) | 1 13/16" (46mm) |
| ANSI Function | 02 | 03 | 03 | 11 or 12 Field Selectable | 11 or 12 Field Selectable |
| Cylinder Type | — | Rim | Rim | 1 1/4" Mortise | 1 1/4" Mortise |

| | Thumbturn-Blank Escutcheon Always Operable (No Cylinder)  | Thumbturn-Blank Escutcheon Always Operable (No Cylinder)  | Thumbturn Key Locks & Unlocks  | Thumbturn-Blank Escutcheon Always Operable (No Cylinder)  |
|------------------|--|--|--|--|
| Trim Description | 360T-BE x 550DT | 360T-BE x IVES 8190 10" | 374T or 376T x 392-6 | 374T-BE or 376T-BE x 392-6 |
| Base Size | 7 1/2" h X 1 11/16" w X 7/8" d (190x43x22mm) | 7 1/2" h X 1 11/16" w X 7/8" d (190x43x22mm) | 7 1/2" h X 1 11/16" w X 7/8" d (190x43x22mm) | 7 1/2" h X 1 11/16" w X 7/8" d (190x43x22mm) |
| Grip Size | — | — | 8 1/2" h X 4 5/16" w (216x110mm) | 8 1/2" h X 4 5/16" w (216x110mm) |
| Projection | 1 13/16" (46mm) | 1 13/16" (46mm) | 1 13/16" (46mm) | 1 13/16" (46mm) |
| ANSI Function | — | — | 11 or 12 Field Selectable | — |
| Cylinder Type | — | — | 1 1/4" Mortise | — |

**Note: 360L & 360T used on Wood Door require the 33A-WDA cover plate
 374T or 376T used on Wood Door require #10-WDA cover plate.**

VON DUPRIN® 33A/35A Strike/Stile Information

Strike Application/Minimum Stile

| Device Type | Standard | | Double door | | Optional | | Double door | |
|-------------|--------------------|---------------|-----------------------------|----------------|--------------------|---------------|-------------------|----------------|
| | Single door Strike | Stile | Strike w/Mullion* | Stile | Single door Strike | Stile | Strike w/Mullion* | Stile |
| 33A | | | | | 299 | 2 3/4" (70mm) | 299 x 5654 | 2 5/8" (67mm) |
| 35A | 1439 | 1 3/4" (44mm) | 1408 x 5754 | 1 3/4" (44mm) | 1410 | 1 3/4" (44mm) | 299 x 4954 | 3 5/16" (84mm) |
| | | | | | 1606 | 2 1/2" (64mm) | 1606 x 1654 | 2 3/4" (70mm) |
| 3327A | 266 (Top) | | 266 (Top) | | 299 (Top) | | 299 (Top) | |
| 3527A | 304L (Bottom) | 1 3/4" (44mm) | 304L (Bottom) | 1 3/4" (44mm) | 385A (Bottom) | 3 1/8" (79mm) | 385A (Bottom) | 3 1/8" (79mm) |
| | 248L-4 (Bottom) | | 248L-4 (Bottom) | | 260U (Top) | | 260U (Top) | |
| | | | | | 385A (Bottom) | 2 1/8" (54mm) | 385A (Bottom) | 2 1/8" (54mm) |
| 3327A-F | — | — | 299F (Top) | 2 3/16" (56mm) | — | — | — | — |
| 3527A-F | — | — | 304L (Bottom) | — | — | — | — | — |
| 3327A-LBR-F | — | — | 499F (Top) | 3 5/8" (92mm) | — | — | — | — |
| | | | (Req. Auxiliary Fire Latch) | | | | | |
| 3347A | | | | | | | | |
| 3547A | 338 (Top) | 2 1/2" (64mm) | 338 (Top) | 1 3/4" (44mm) | 304L (Bottom) | 2 1/2" (64mm) | 304L (Bottom) | 2 1/2" (64mm) |
| 3348A | 385A (Bottom) | | 385A (Bottom) | | | | | |
| 3548A | | | | | | | | |
| 3347A-F | — | — | 338 (Top) | 3 1/2" (89mm) | — | — | 304L (Bottom) | 3 1/2" (89mm) |
| 3547A-F | — | — | 385A (Bottom) | — | — | — | — | — |
| 3348A-F | — | — | | | — | — | | |
| 3548A-F | — | — | | | — | — | | |
| 3347A-LBR | | | | | | | | |
| 3547A-LBR | 338 (Top) | 2 1/2" (64mm) | 338 (Top) | 2 1/2" (64mm) | — | — | — | — |
| 3348A-LBR | | | | | | | | |
| 3548A-LBR | | | | | | | | |
| 3347A-LBR-F | — | — | 338 (Top) | 3 5/8" (92mm) | — | — | — | — |
| 3547A-LBR-F | — | — | | | — | — | — | — |

*Mullion information — Refer to the General and Auxiliary Catalog.

Strikes for Rim Devices

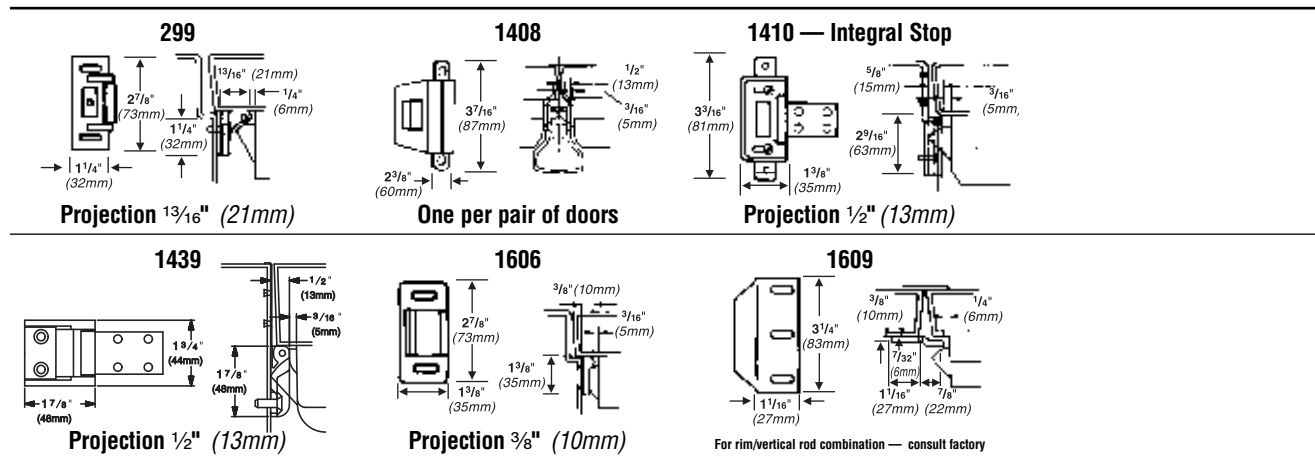

Strikes for Vertical Rod Devices

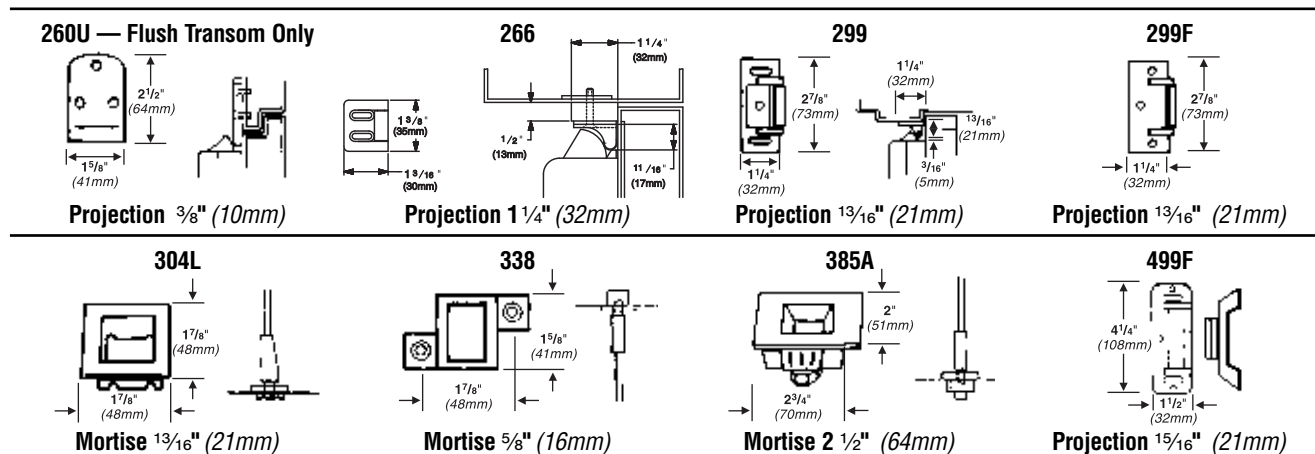

ANSI Grade, Type & Function

| Function | Grade 1, Type 4 | Grade 1, Type 5 | Grade 1 Type 6, 7 & 8 | |
|----------|--|--|--|--|
| 01 | 33A-EO 35A-EO | 3327A-EO 3327A-EO-F 3527A-EO 3527A-EO-F | 3347A-EO 3347A-EO-F 3348A-EO 3348A-EO-F | 3547A-EO 3547A-EO-F 3548A-EO 3548A-EO-F |
| 02 | 33A-DT 35A-DT | 3327A-DT 3527A-DT | 3347A-DT 3348A-DT | 3547A-DT 3548A-DT |
| 03 | 33A-NL 33A-NL-OP 35A-NL 35A-NL-OP | 3327A-NL-OP 3527A-NL-OP 3327A-NL-OP-F 3527A-NL-OP-F 3527A-NL 3327A-NL-F 3527A-NL 3527A-NL-F | 3347A-NL-OP 3347A-NL-OP-F 3348A-NL-OP 3348A-NL-OP-F 3347A-NL 3347A-NL-F 3348A-NL 3348A-NL-F | 3547A-NL-OP 3347A-NL-OP-F 3548A-NL-OP 3548A-NL-OP-F 3547A-NL 3547A-NL-F 3548A-NL 3548A-NL-F |
| 08-09 | 33A-L 35A-L | 3327A-L 3327A-L-F 3527A-L 3527A-L-F | 3347A-L 3347A-L-F 3348A-L 3348A-L-F | 3547A-L 3547A-L-F 3548A-L 3548A-L-F |
| 11-12 | 33A-TL 35A-TL | 3327A-TL 3327A-TL-F 3527A-TL 3527A-TL-F | 3347A-TL 3347A-TL-F 3348A-TL 3348A-TL-F | 3547A-TL 3547A-TL-F 3548A-TL 3548A-TL-F |

Dimensions

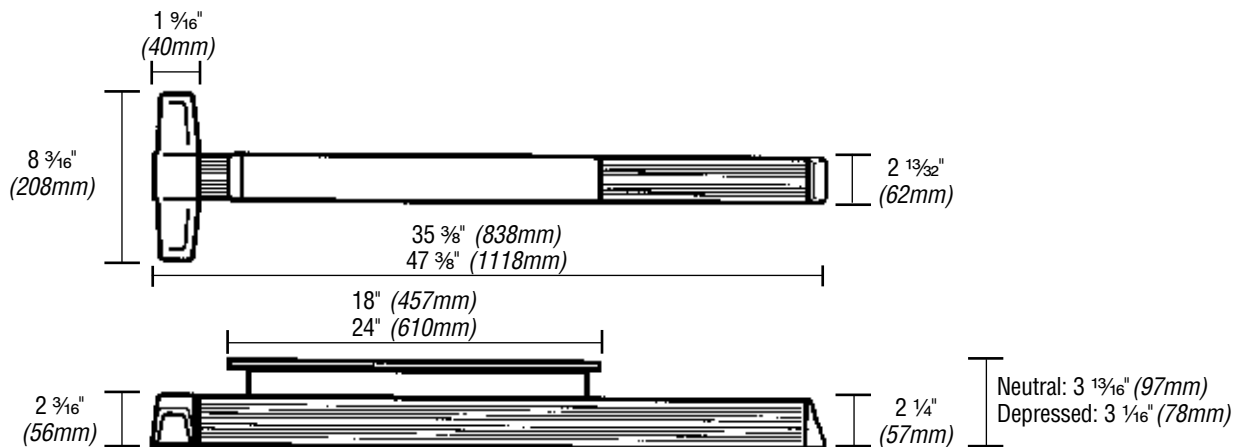

Electrical Options

Alarm Kit – ALK



The ALK battery alarm kit is a simple yet effective way to deter unauthorized use of an opening. While the exit device is still a means of egress, the ALK kit contains an internal horn. When the touch bar is depressed, the horn sounds to provide an audible means of signaling that the opening has been violated. The alarm kit can be armed or disarmed by key. Thus allowing the exit device to be set in an armed or disarmed mode. The horn is rated at 85 decibel.

The key switch uses a standard 1¼" (32mm) mortise cylinder with a straight cam (Schlage Cam reference B502-191). The unit operates on one standard 9-volt alkaline battery. When the battery is weak, the horn will emit an intermittent low battery alert signal.

Also can be powered using the PS9 Power Supply. See PS9 for additional information.

Alarm kits are available with a choice of two switch kits, RX or LX. RX monitors the touchpad and is furnished standard. LX optional latch bolt monitoring is recommended for use with surface vertical rod exit devices. Specify ALK-LX.

The ALK is available in two styles, 33A/99ALK, grooved cover and 35A/98ALK, smooth cover.

The ALK includes "EMERGENCY EXIT ONLY. ALARM WILL SOUND" decal for application on door, or the SS push bar trim can be used instead of the door decal, specify SS push bar trim.

The ALK is available with 2 optional circuit boards. External Inhibit (EI) allows for the use of external switch to be used to arm, disarm and reset the alarm. Auto Reset (AR) rearms the alarm after a preset time. AR is available in three factory set times – 1½, 3 or 6 minutes.

To Order, Specify:

1. External Inhibit – ALK-EI
2. Auto Reset – ALK-AR3

When the ALK is used, standard dogging is removed. If cylinder dogging is required there are two choices. Special center case dogging is available or for 3' or 4' doors the ALK can be moved to the hinge side of the device and standard cylinder dogging can be added.

To Order, Specify:

1. Standard, 33ANL ALK
2. Cylinder Dogging, CD33ANL ALK

Minimum Door Sizes

| Device | 3' (914mm) Length | 4' (1219mm) Length |
|--------------------------------|----------------------|-----------------------|
| 33A/35A | 2'9" (838mm) | 3'3" (991mm) |
| 3327A/3527A | 2'8" (813mm) | 3'2" (966mm) |
| 3347A/3347A-F 3547A/3547A-F | 2'8" (813mm) | 3'2" (966mm) |
| 3348A/3348A-F 3547A/3547A-F | 2'8" (813mm) | 3'2" (966mm) |

Request to Exit — RX



The RX (Request to Exit) feature is used to signal the use of an opening. This device is equipped with one internal SPDT switch which monitors the pushpad.

The device can be connected to a security console, or may be used as a single door alarm when used with a horn and power supply. A continuous current electric transfer must be used for transferring power from the frame to the door.

The RX switch option should not be used to control a load, but as a signalling switch (0.5 amps. resistive maximum).

The RX switch is available in a low current (LC) switch. Most commonly used in computer operated monitoring systems.

To Order, Specify:

- Standard – Use prefix RX, example RX33AEO
- Low Current – Use prefix RX-LC, example RX-LC35AEO

Double Request to Exit — RX2

The RX2 feature uses 2 RX switches. Also available with the Low Current (LC) switch.

To Order, Specify:

- Standard – Use prefix RX2, example RX233AEO
- Low Current – Use prefix RX2-LC, example RX2-LC35AEO

Latch Bolt Monitoring — LX

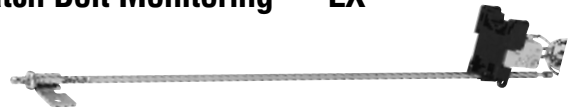

The LX feature is used to signal the use of an opening. This device is equipped with one internal SPDT switch which monitors the latch bolt.

The device can be connected to a security console, or may be used as a single door alarm when used with a horn and power supply. A continuous current electric transfer must be used for transferring power from the frame to the door.

The LX switch option should not be used to control a load, but as a signalling switch (0.5 amps. resistive maximum).

The LX switch is available in a low current (LC) switch. Most commonly used in computer operated monitoring systems.

To Order, Specify:

- Standard – Use prefix LX, example LX33AEO
- Low Current – Use prefix LX-LC, example LX-LC35AEO

Electrical Rating for all Switches:

- Standard – up to 0.5 Amp @ 24VDC Maximum
- Low Current (LC) - up to .05 Amp @ 24VDC Maximum

Note: All Switches can be either factory or field installed

Electrical Options

Electric Latch Retraction — EL



The EL feature allows for the remote unlatching of exit devices. A control station operator can flip a switch to retract the latch bolt and immediately change an exit door to push-pull operation. A powerful, continuous duty solenoid retracts the latch bolt, either for momentary unlatching, or for extended periods of time. The EL feature is an alternative to manual dogging. If manual hex-key dogging is required, specify HD-EL.

EL devices are also useful with automatic door operators, and may be applied to fire-rated applications when under the control of an **automatic fire alarm system**.

UL approved for Class II circuit applications.

The EL option does not include the power transfer from door to frame, the power supply, or the control operator. Refer to EPT-2 power transfer and the PS873 power supply.

The PS873 with the 871-2 option card is minimum option card required. Other option cards available for other functions, see PS873 power supply for additional information.

Solenoid Specifications:

Continuous Duty — 24 VDC

Current Inrush — 16 Amps

Current Holding — 0.3 Amps

To order, specify:

Standard — Use prefix EL, example EL33AL.

Hex Key dogging — Use prefix HD-EL, example HD-EL33AL.

Popular EL Application

Power Supply PS873-2

Electric Power Transfer EPT-2 or EPT-10

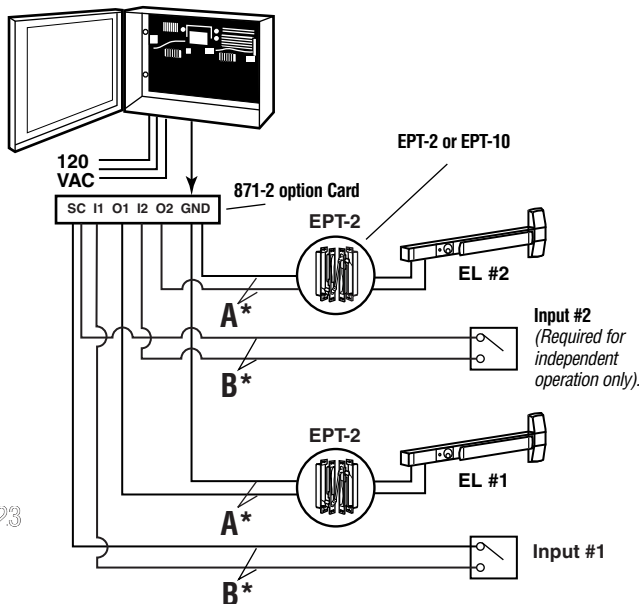

23

Signal Switch — SS



Monitors pushpad and latch bolt

The SS feature is used to signal the unauthorized use of an opening. This device is equipped with two internal SPDT switches. One switch monitors both the pushpad and the latch bolt assembly, making the latch bolt tamper resistant, for positive security. An additional SPDT switch is connected to the 1 1/4" (32mm) mortise with straight cam for alarm "bypass." (Schlage cam reference B502-191). The device can be connected to a security console, or may be used as a single door alarm when used with a horn and power supply. A continuous current electric transfer must be used for transferring power from the frame to the door.

Pushpad reads:

"EMERGENCY EXIT ONLY – PUSH TO OPEN AND SOUND ALARM." Pushpad is only available in US32D finish with red silk-screened lettering.

To Order, Specify:

1. Prefix SS, example SS33AL.
2. Handing Required, LHR or RHR.

Electrical Ratings:

Up to 2.0 AMPS @ 24VDC

Popular SS Application

Unauthorized use of this opening will activate the local horn.

The key switch permits inhibiting this system for authorized entry.

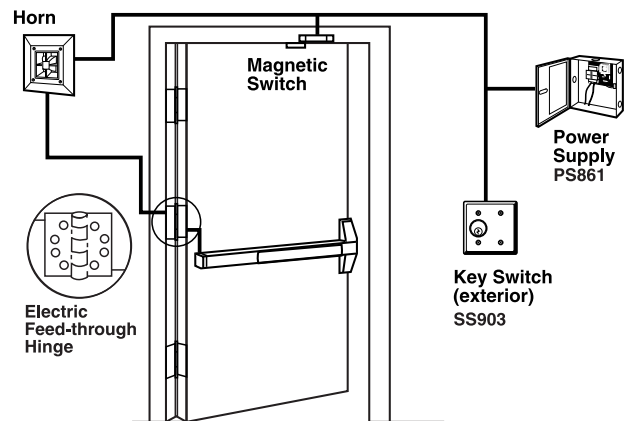

EL Device Wire Selection Size

| A* | Run Length | EL Device w/EPT or Door Loop |
|----|----------------|----------------------------------|
| | 0-100 ft. | 14 gauge |
| | 0-200 ft. | 12 gauge |
| A* | Run Length | EL Device w/Electric Hinge/Pivot |
| | 0-75 ft. | 14 gauge |
| | 0-150 ft. | 12 gauge |
| B* | Wire Selection | Switch Wire Size |
| | 1200 ft. Max. | 18 gauge |

Electrical Accessories

Power Supplies



SERIES PS873

The series PS873 power supply is designed to operate a wide variety of electrical products. EL panics require 871-2 PCB minimum. The regulated output power is field selectable for either 24VDC @ 2 ampere or 12VDC @ 4 ampere. Standard input 120VAC @ 1.0 ampere or 240VAC @ 0.5 ampere available. Enclosure is 10" high x 12½" wide x 5" deep (254mm x 323mm x 127mm), gray with a hinged cover and constructed of heavy 19 gauge steel. Five ½" x ¾" (13mm x 19mm) knockout holes are provided for conduit connection. Terminal block will accept up to 12 gauge wire.

The PS873 can be ordered with three standard options: **Key lock** secures the cover to eliminate tampering and provides safety; **Battery backup** provides two hours backup power at full load during a A.C. power failure. Batteries will automatically recharge when failed power is restored. **Fire Alarm** provides input for a normally closed fire alarm contact. When the fire alarm contact is "open", power to locks or other component is removed. Restoring power is field selectable for automatic or manual.

Eight standard configurations:

| | |
|------------|--------------------------------------|
| PS873 | Standard |
| PS873K | With keylock |
| PS873B | With battery |
| PS873BK | With battery and keylock |
| PS873FA | With fire alarm |
| PS873K-FA | With keylock and fire alarm |
| PS873B-FA | With battery and fire alarm |
| PS873BK-FA | With battery, keylock and fire alarm |

The series PS873 is available with several optional circuit cards to provide system flexibility. The power supply will accept one or a combination of any two cards.

Factory or Field Installed Circuit Cards:

871-2, Two Zone controller provides two inputs and two outputs. Will operate one or two EL exit devices. Use suffix "-2" for factory installed, example PS873-2.

873-AL, Alarm function monitors 1 or 2 zones and provides alarm output, upon detecting a door in the open position. Delayed alarming is selectable from 5 to 75 seconds. Use suffix "-AL" for factory installed, example PS873-AL

873-AO, Auto Operator function coordinates the release of one or two locks and signals an auto-operator to open a door. Signaling the auto operator can be performed in two methods; by receiving a signal from a monitoring switch that the lock is unlatched, or upon expiration of a time delay triggered by a "RX" type input switch. Use suffix "-AO" for factory installed, example PS873-AO

873-SI, Security/Safety Interlock provide interlock function for two zones. When combined with a second 873-SI card, the inter-locking of groups are available in two, three or four zones. Safety interlock is available, consult factory for additional information. Use suffix "-SI" for factory installed, example PS873-SI

873-4TD, Four Zone controller with **Time Delay** provides four inputs and four outputs with time delay. Time delay is field selectable from 0 to 75 seconds, in intervals of 5 seconds. Will operate up to 4 EL devices. Use suffix "-4TD" for factory installed, example PS873-4TD

873-AC, Access Control provides supervision of one zone using an electromagnetic lock. Input signals required are: access control contact, motion detector contact, and motion detector override contact. FA, Fire Alarm option is required. Use suffix "-AC" for factory installed, example PS873-AC

Factory Installed Only Circuit Card

873-DE, Delayed Egress provides 15 second delay release from pushbar activation to electro-magnetic lock release. Ideal function for use with Locknetics electromagnetic locks, will operate two zones simultaneously. To operate two separate zones, a second 873-DE card is required. UL listed component, when used as part of a Von Duprin delayed egress system. Use suffix "- DE", example, PS873-DE.

Note: "DE" cards CANNOT be combined with any other optional cards.

Electrical Accessories

Power Supplies PS861 Power Supply

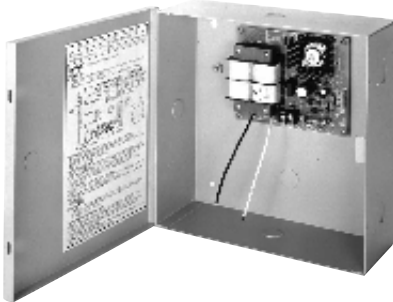

**Standard
UL Listed
Class 2, Power Supply
UL1012
UL1310**

The series PS861 power supply is designed for electric locking or monitoring on single or double door applications. The output power is field selectable for either 24 VDC @ 1 ampere or 12 VDC @ 2 ampere. Standard input 120 VAC @ 0.6 ampere and 240 VAC @ 3.0 ampere available. The terminal block will accept up to 14 gauge stranded wire.

The gray enclosure is 10" x 10" x 4" (254mm x 254mm x 102mm), has a hinged cover, and is constructed of heavy 19 gauge steel. Six ½" (13mm) knockout holes are provided for conduit connection.

Options include keylock cover or Battery Backup. The pair of batteries, which are sealed lead acid battery packs, will provide back-up power for three hours at full load or seven hours at half load. Batteries will automatically recharge when failed power is restored.

Four Models:

| | |
|-----------|---|
| PS861 | Standard supply |
| PS861K | Standard supply with keylock cover |
| PS861B | Battery backup |
| PS861FA | Fire Alarm |
| PS861BK | Battery backup and keylock cover |
| PS861BKFA | Battery backup and keylock cover with FA board (24VDC only) |

PS9 Power Supply

The PS9 is an AC power supply that provides 9 VDC power to operate the ALK alarm kit. The unit will power one or two alarm kits. Included is a 9-volt sealed battery that provides backup power in case of an AC power failure.

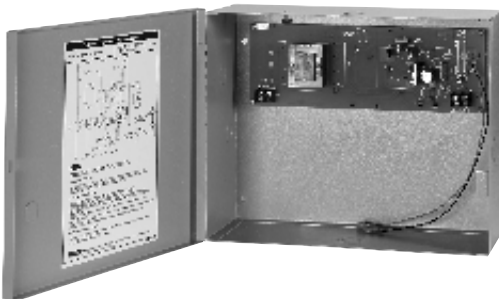

Electrical Power Transfer — EPT Pneumatic Transfer – PNT



Electric Power Transfer provides a means of transferring electrical power from a door frame to the edge of a swinging door. The units are completely concealed when the door is in the closed position, and are ideally suited for installations involving abuse or heavy traffic.

Two models are available; EPT-2, two 18 gauge wires and EPT-10, ten 24 gauge wires. The EPT-2 and EPT-10 are UL listed as "miscellaneous door accessory".

Pneumatic Controls

PNT-1 is available for pneumatic latch retraction exit devices. Appearance and dimensions are identical to EPT models.

UL Listed for use on fire doors

Door applications:

up to 5" butt hinges – 180° swing,
5 ½" butt hinges – 130° swing,
6" butt hinges – 110° swing,
¾" butt offset pivots 180° swing.

Not for use with swing clear hinges or center-hung pivots.

Finishes

SP28 (sprayed aluminum)
SP313 (sprayed duranodic).

Dimensions

| | |
|---------|--|
| Housing | 9" x 1 ¼" x 1 ⅝" (229mm x 32mm x 38mm) |
| EPT-2 | Two 18 gauge wires, Up to 2 AMPS @ 24VDC, with a 16 AMPS Maximum Surge |
| EPT-10 | Ten 24 gauge wires, Up to 1 AMPS @ 24VDC, with a 16 AMPS Maximum Surge |
| PNT-1 | ⅝" Tubing |

To order, specify:

1. EPT-2, EPT-10 or PNT-1.
2. Finish, SP28 or SP313.

Pneumatic Controlled Exit Devices—PN



The PN feature provides remote latch bolt retraction in hazardous areas where electrically operated devices would not be permitted. The pneumatic solenoid will retract the latch bolt for momentary or prolonged periods. PN exit devices are particularly suited for use with automatic door operators. The PN feature is available on both Panic and Fire Exit Hardware devices.

The PN feature includes a special actuating linkage that gives building owners the option of mechanically or pneumatically dogging the exit device. If manual hex-key dogging is required, specify HD-PN (Dogging the device, whether mechanically or pneumatically, makes the device function as a push/pull unit and reduces the wear on its moving parts.)

When activated pneumatically, the latch bolt(s) of the exit device retract in ½ to 1 ½ seconds. This pneumatic operation uses air pressure ranging from 50 to 100 pounds per square inch.

This product will function only when it is part of a pneumatic system (air compressor, air lines, pneumatic system, etc.). Contact LCN for correct control boxes

To Order, Specify:

- Standard — Use prefix PN, example PN33ANL
- Hex Key Dogging — Use prefix HD-PN, example HD-PN33ANL

Less Dogging – LD

Less Dogging is available in all 33A/35A Panic Exit devices to remove the dogging option.

To Order, Specify:

- Use prefix LD, example LD33AL

Cylinder Dogging — CD



Cylinder dogging is available on all 33A/35A Panic Exit devices to replace the standard hex key dogging. Unit requires a standard 1 ¼" (32mm) mortise cylinder with a straight cam (Schlage Cam B502-191 reference).

To Order, Specify:

- Use prefix, CD, example CD33AL

Cylinder Dogging Kit — CDK

For field conversion, a cylinder dogging conversion kit is available. Cannot be added to fire exit hardware.

Order: 33A/99CDK or 35A/98CDK, specify finish.

Hex Key Dogging Kit — HDK

For field conversion, a hex key dogging conversion kit is available. Cannot be added to fire exit hardware.

Order: 33A/99HDK or 35A/98HDK, specify finish.

Dummy Pushpad



The 330 dummy pushpad is designed as a companion unit for all 33A devices. The 350 dummy pushpad is a companion unit for all 35A devices. The pushpad is rigid or nonfunctioning. A push/pull operation can be accomplished by using 386DT, 360L-DT, 550DT, 392-6 trim or any Ives Pull.

The 330/350 can be equipped with a functional pushpad and will accommodate an RX switch. Specify RX-330. May also be equipped with the RX2, double RX switch. Specify RX2-330

To order, specify:

1. 330 or 350.
2. Size 3' or 4' (914mm or 1219mm)
3. Finish, US3, US4, US10, US26, US26D, US28, 313AN, 315AN, 350 Only US32D.

Vertical Rod and Latch Guard — RG-27

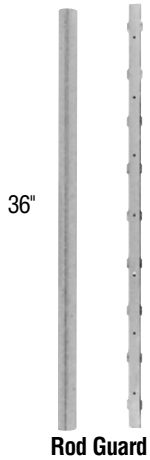

Series RG-27 Vertical Rod and Latch Guards protect the bottom rods of exit devices from the damaging impacts of carts or gurneys passing through doors. (If bottom rods become damaged, the exit device will not function as intended and can jeopardize the ability to exit safely during an emergency.)

In addition to protecting the vertical rod, the guard provides a smooth, unobstructed surface so the door can be pushed open easily with the bumpers of a wheelchair. The latch guard portion is 10" high. The standard latch guard features a 45° ramp. The extended latch guard offers a continuous ramp in 3' or 4' widths.

All stainless steel construction in US32D finish. Latch guards can cover latches as large as 1 1/4"W x 10"H x 1 7/8" projection.

Models

RG0 — Rod guard only (Projection 1 3/16").

RG-27 — Rod and latch guard.

RG-27-3 — 3' (914mm) Rod Guard and Extended Latch Guard.

RG-27-4 — 4' (1219mm) Rod Guard and Extended Latch Guard.

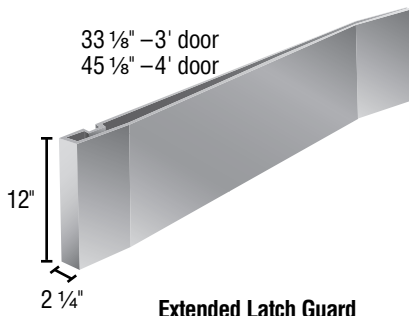
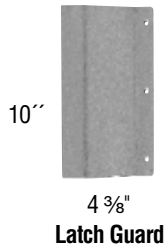

LGO — Latch guard only.

LGO-3 — 3' (914mm) Extended latch guard only.

LGO-4 — 4' (1219mm) Extended latch guard only.

Note: Not for use on wood fire doors

To Order, Specify:

1. Model number.
2. Handing (except on RG0).
3. Door material if other than Hollow Metal.
4. Optional sex bolt mounting available.

Less Bottom Rod – LBR

LBR option is available, using a spring loaded auxiliary latch bolt installed in the lower door edge. When exposed to heat the auxiliary latch bolt releases, keeping the doors in alignment and closed during a fire. UL listed 3 hours on hollow metal doors double egress, 90 minute swinging same direction, and 20 minutes wood doors (consult wood door manufacturer). Fits door stiles as narrow as 3 5/8".

LBR devices must be ordered in pairs or must be used in conjunction with an approved automatic or constant latching flush bolt.

LBR used on non-fire rated devices, the spring loaded auxiliary latch bolt is not required. Device is supplied less bottom rod, latch and strike.

Pullman Latch – PL

When PL is specified the standard latches are replaced with pullman style latches. Pullman latches are always extended and are most commonly used in conjunction with electric strikes and LBR-less bottom rod application. Not available with Fire rated devices. Not recommended where security is of the utmost since latches do not deadlock.

Glass Bead Kit – GBK

Glass bead conversion kits are available for all 33A/35A Series devices for use on doors with raised glass beads. Each kit consists of 1/4" (6mm) shim sets. GBK for Surface Vertical Rod ships with 1/8" shims for rod guides.

To order, specify:

1. 33AGBK
2. Device type (Rim, Mortise, Surface Vertical Rod, Concealed Vertical Rod)
3. Wood Door, when used with Concealed Vertical Rod

UL Listed — Fire Exit Hardware Label/ Opening Size

| Double Door | | |
|-------------|-------------------|-------------------|
| Exit Device | Same Direction | Double Egress |
| 3327A-F | 90 Min. 8' x 10' | 3 Hour 8' x 10' |
| 3527A-F | 90 Min. 8' x 10' | 3 Hour 8' x 10' |
| 3347A-F | 90 Min. 8' x 10' | 3 Hour 8' x 10' |
| 3547A-F | 90 Min. 8' x 10' | 3 Hour 8' x 10' |
| 3347A-F-WDC | 90 Min. 8' x 9'3" | 90 Min. 8' x 9'3" |
| 3547A-F-WDC | 90 Min. 8' x 9'3" | 90 Min. 8' x 9'3" |
| 3348A-F | 90 Min. 8' x 10' | 3 Hour 8' x 10' |
| 3548A-F | 90 Min. 8' x 10' | 3 Hour 8' x 10' |

Handing of Doors

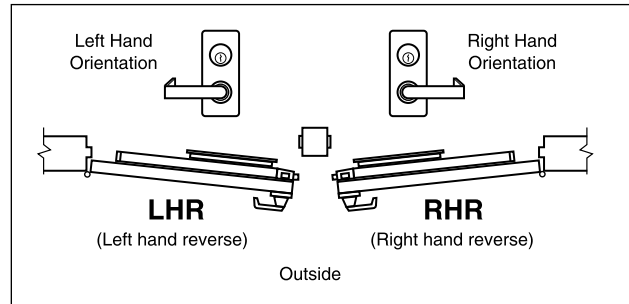

Cylinders

Cylinders are not furnished with device or trim and must be specified when ordering. Rim, surface vertical rod, and concealed vertical rod exit devices use rim type cylinders. **EXCEPTION:** Devices using 360 and 370 controls use 1 1/4" mortise cylinders.



Mortise — 3215 (Schlage B502-191 cam)

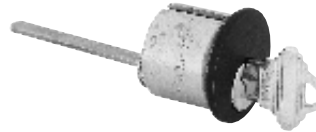
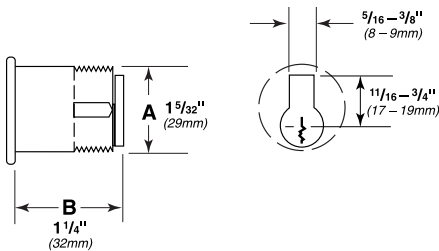

Rim 3216

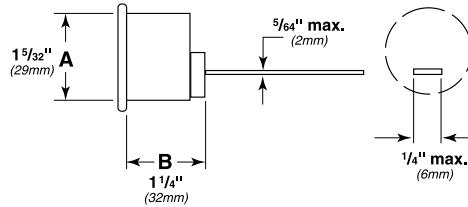

**Dogged Cam
(Inverted)**

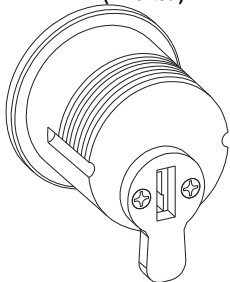

For standard locking trim on 360 controls
and for Cylinder Dogging.

**Undogged Cam
(Standard Option)**

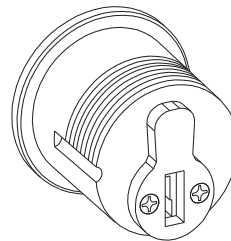

For NL function on 360 controls.

Popular Double Door Applications

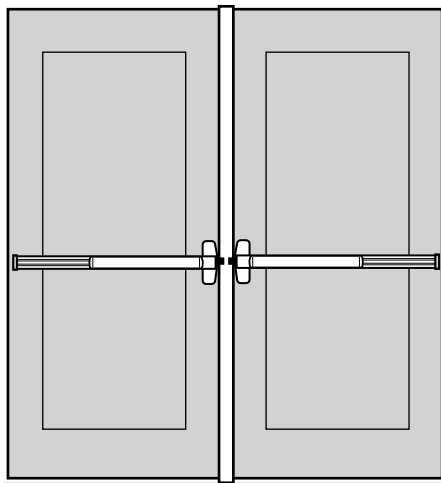

Two rim devices with mullion — same direction

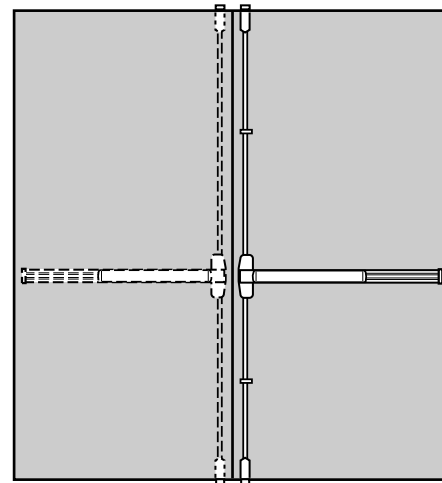

Two vertical rods — double egress

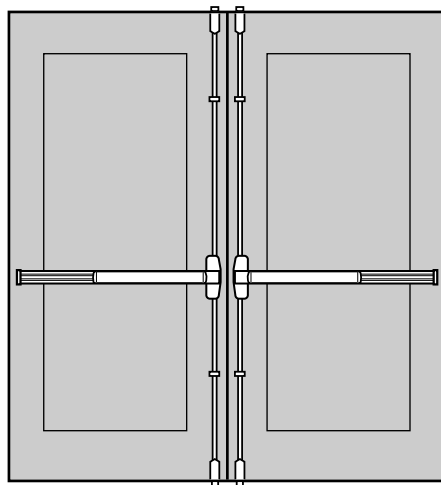

Two vertical rod devices — same direction (do not use with overlapping astragal)

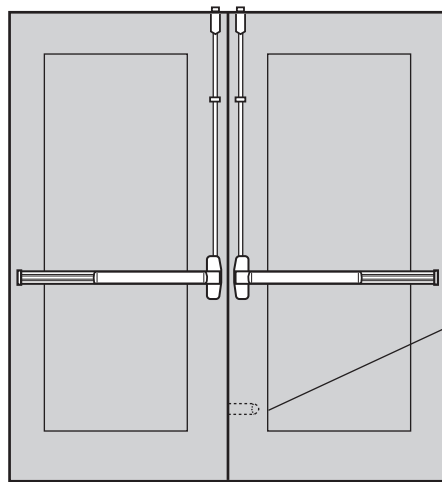

Auxiliary Fire Latch

Two FEH vertical rods with auxiliary fire latch — LBR option

Rim devices, specify:

- Exit device model number with trim selection.
Examples: 33A-EO (exit only with no outside trim).
33A-NL (includes 386NL trim). 33A-NL-OP
(includes the 388 trim less pull).
- Size 4' (1219mm) for door sizes 3'1" (940mm) to 4' (1219mm).
Size 3' (914mm) for door sizes 2'6" (792mm) to 3' (914mm)
is shipped standard.
- Door thickness if other than 1 3/4" (44mm).
- Door and frame material if other than hollow metal.
- Finish, see inside front cover.
- Handing required on "L," "SS," or "386NL." Specify LHR or RHR.
See page 28.

Vertical rod devices, specify:

- Exit device model number with trim selection.
Examples: 3327A-EO (exit only with no outside trim.)
3327A-TL-OP (includes 360T Control) 3327A-TL (includes 374T
and 386DT).
- Size 4' (1219mm) for door sizes 3'1" (940mm) to 4' (1219mm).
Size 3' (914mm) for door sizes 2'6" (792mm) to 3' (914mm)
is shipped standard.
- Door thickness if other than 1 3/4" (44mm).
- Door height if greater than 7' (2134mm) surface vertical rod
device (8' 4" for concealed devices), extension rods must be
ordered.
- Door and frame material if other than hollow metal.
- Finish, see inside front cover.
- Handing required on "L," "SS," or "386NL." Specify LHR or RHR.
See page 26.

Pullman latches are optional for 3327A/3527A devices. Latchbolts remain extended at all times. Specify "Pullman Latch" when required.

Device trim, Cross-reference:

| 33/35 Devices | Status | 33A/35A Devices |
|---------------|----------|------------------------------|
| 333NL-TP | Replaced | 386NL |
| 333DT | Replaced | 386DT |
| 337NL-TP | Replaced | 386NL |
| 337DT | Replaced | 386DT |
| 334 | Replaced | 388 |
| 334 x 550 | Replaced | 388 x 550 |
| 370L | Replaced | 360L |
| 370T | Replaced | 360T |
| 372L | Replaced | 360L |
| 374T x 333DT | Replaced | 374T x 386DT |
| ----- | New | 374T x 392-6 |
| 376T x 337DT | Replaced | 376T x 386DT |
| ----- | New | 376T x 392-6 |
| 3308NL | Obsolete | ----- |
| 3308DT | Obsolete | ----- |
| ----- | New | 388 x Ives 8190 Series Pull |
| ----- | New | 360T x Ives 8190 Series Pull |

Nomenclature – How To Order

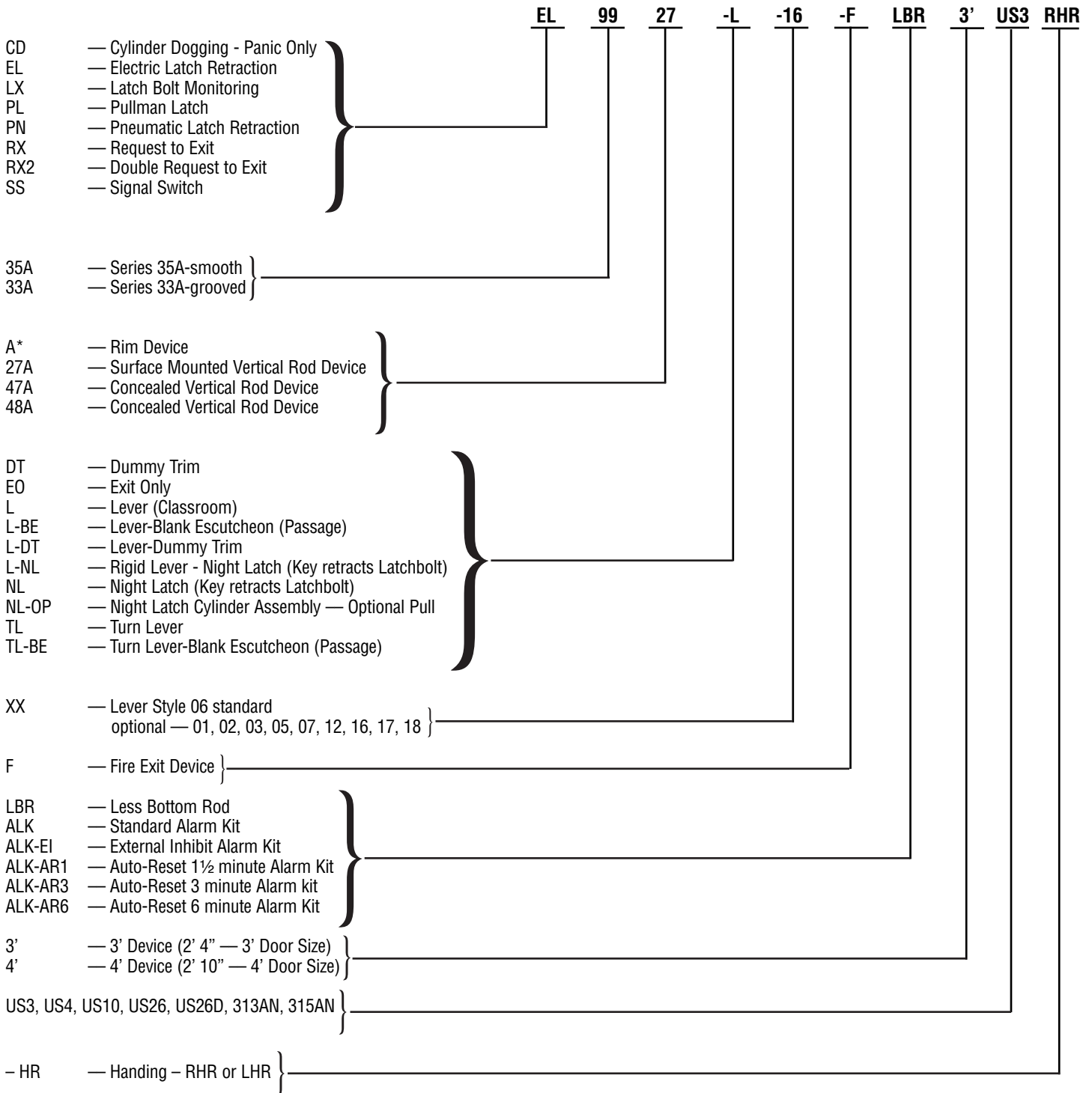

* "A" Suffix indicates new generation design of 33/35 exit devices

33A/35A Series Exit Devices



Visit Von Duprin on the web
www.vonduprin.com



VON DUPRIN

2720 Tobey Drive,
Indianapolis, IN 46219
317-613-8944 phone
317-613-8302 fax
www.vonduprin.com
www.irsecurityandsafety.com

An **IR Ingersoll Rand** business