

# IPTC470 Series

Description: 2 1/4" X 4 1/2" Offset Glazed For 1 1/16" Glass

Function: Impact Storefront

Detail: Horizontals

Scale: 3" = 1'-0"

SHEET 1 OF 3

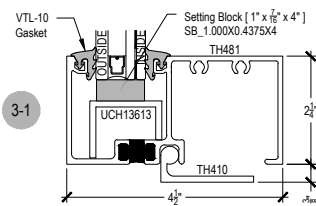
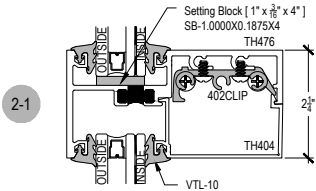
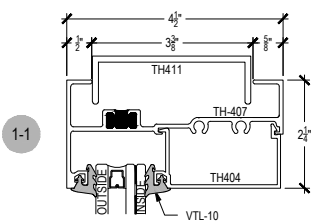

**SHEAR BLOCK  
INSIDE SET**  
Continuous Head / Sill

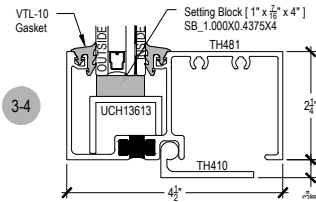
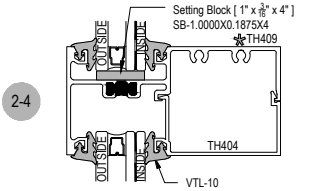
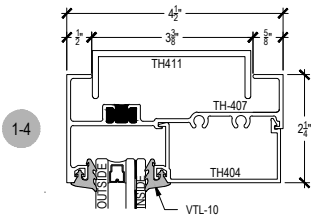

**SCREW RACE  
INSIDE SET**  
Verticals Run Through

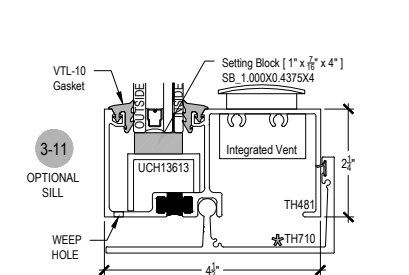
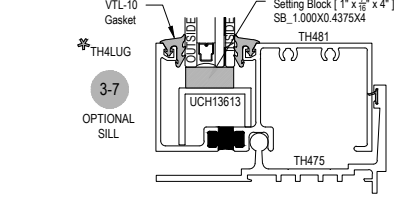
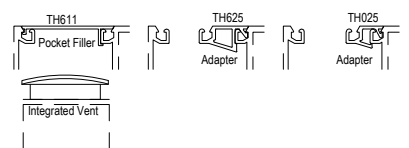
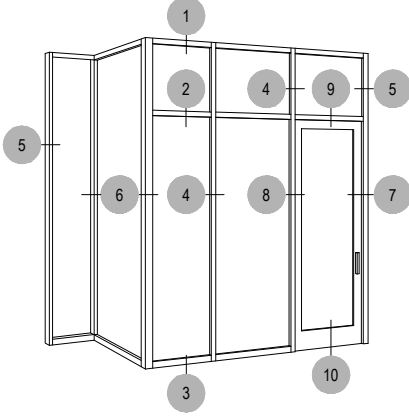
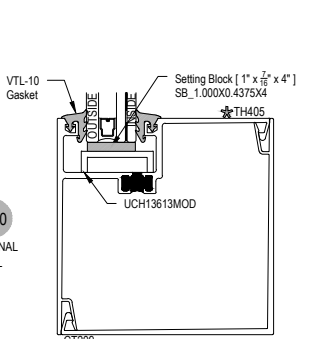
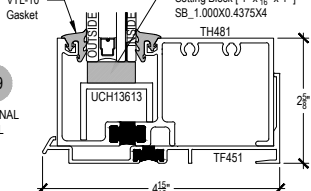
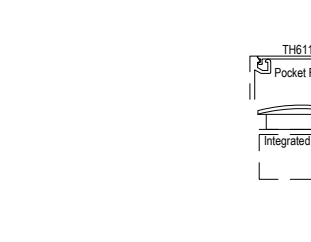
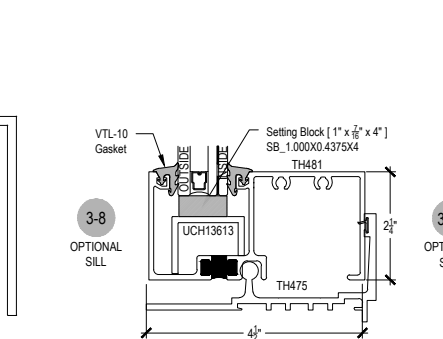
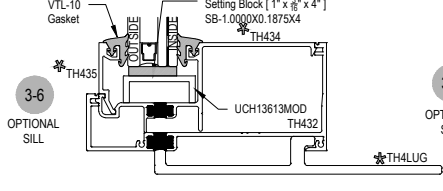
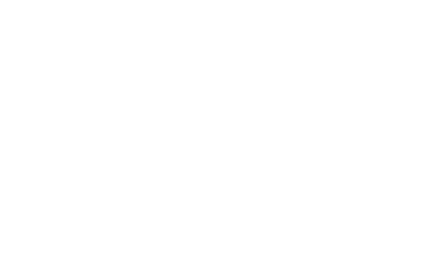
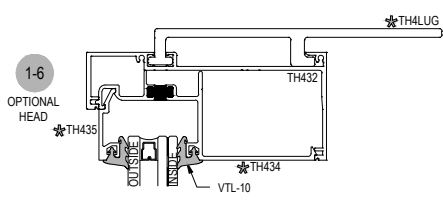
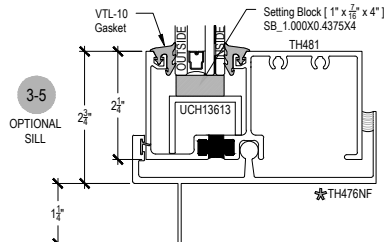
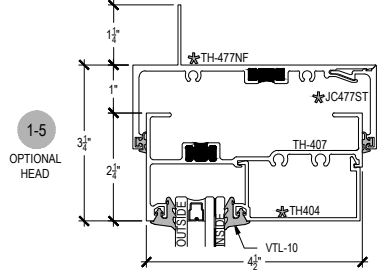
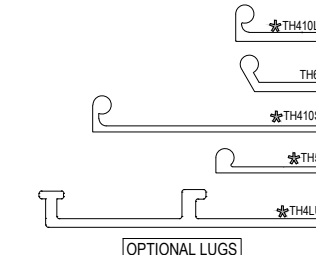

Procedures, instructions, or modifications which may affect pricing and delivery, consult Arcadia customer service.

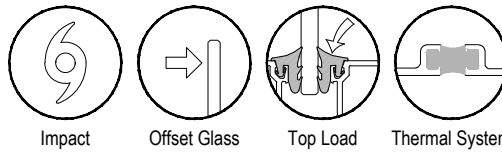

# IPTC470 Series

Description: 2 1/4" X 4 1/2" Offset Glazed For 1 1/16" Glass

Function: Impact Storefront

Detail: Verticals

Scale: 3" = 1'-0"

SHEET 2 OF 3

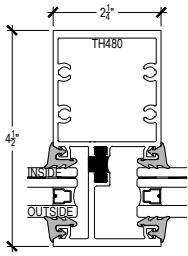

4-1

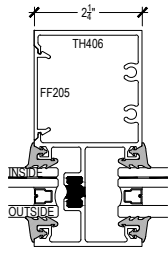

4-2

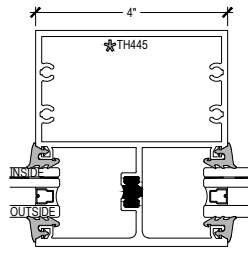

4-3

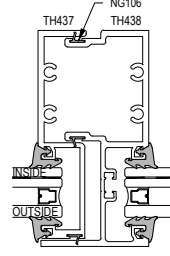

4-4

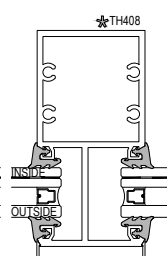

4-5

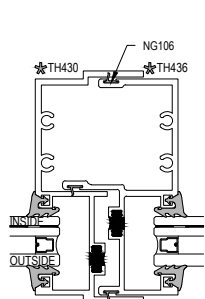
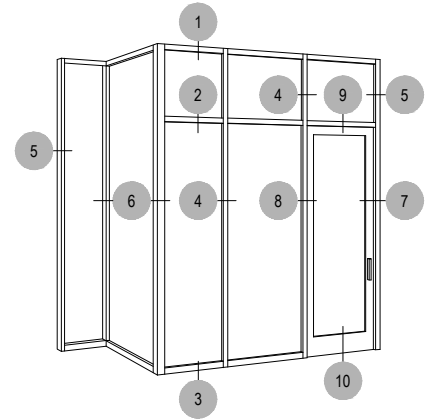

4-6

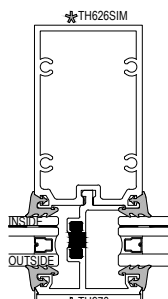

4-7

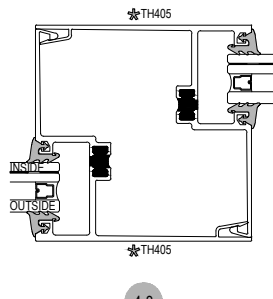

4-8

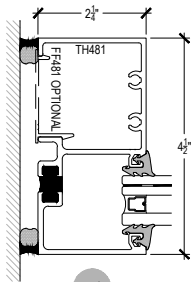
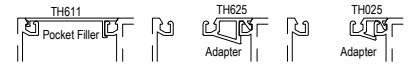

5-1

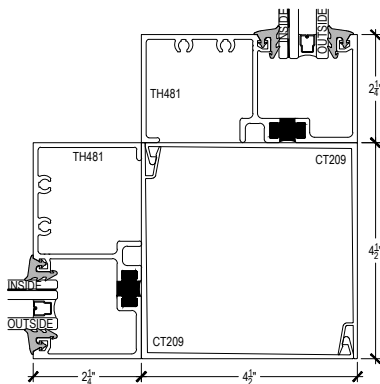

6-1 90° CORNER ASSEMBLY



Procedures, instructions, or modifications which may affect pricing and delivery, consult Arcadia customer service.



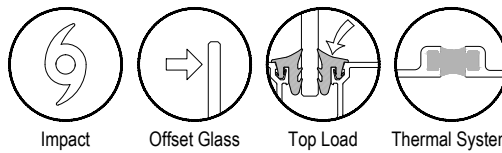

# IPTC470 Series

Description: 2 1/4" X 4 1/2" Offset Glazed For 1 1/16" Glass

Function: Impact Storefront

Detail: Doors

Scale: 3" = 1'-0"

SHEET 3 OF 3

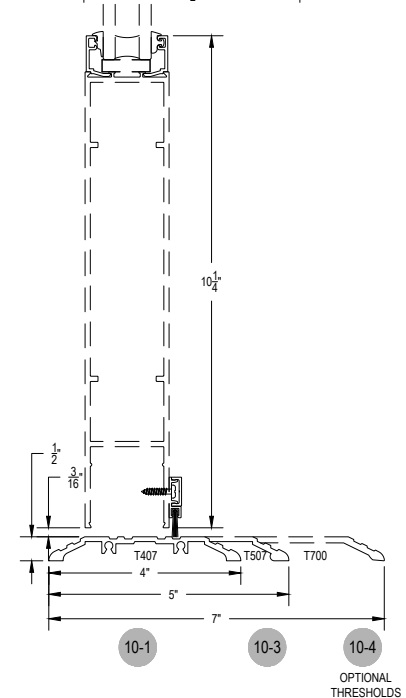
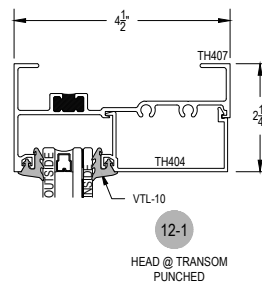
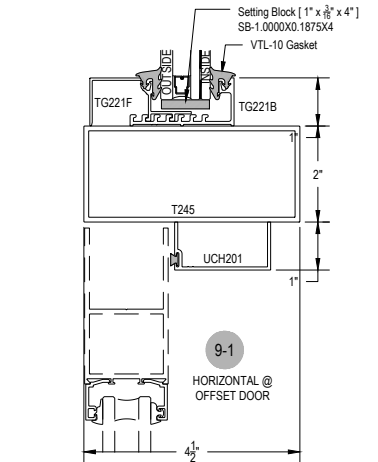
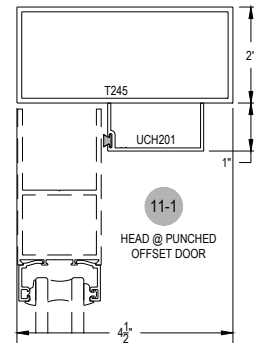
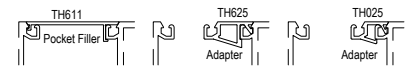
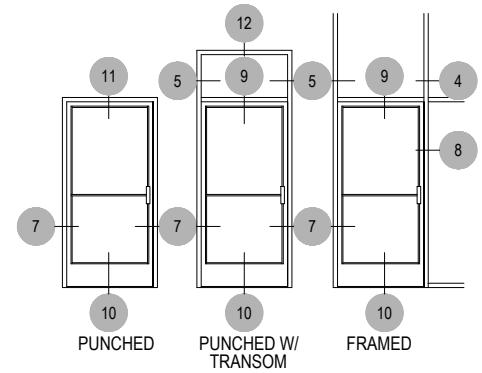
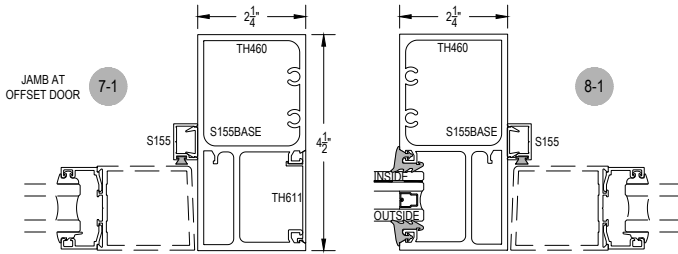

Procedures, instructions, or modifications which may affect pricing and delivery, consult Arcadia customer service.