

Center Glazed

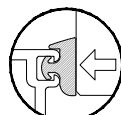

Side Load

AG601 Series

Description: 2" X 6" Center Glazed For 1" Glass

Function: Window Wall

Detail: Horizontals, Verticals

Scale: 3" = 1'-0"

SHEET 1 OF 2

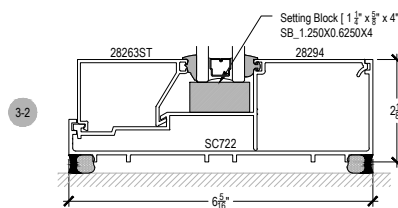
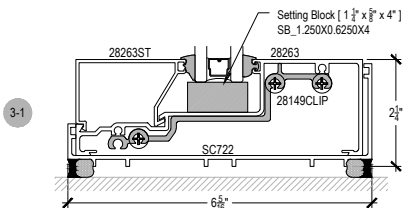
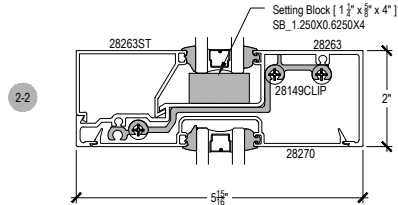
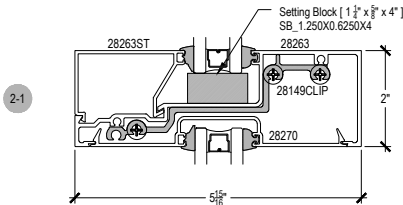
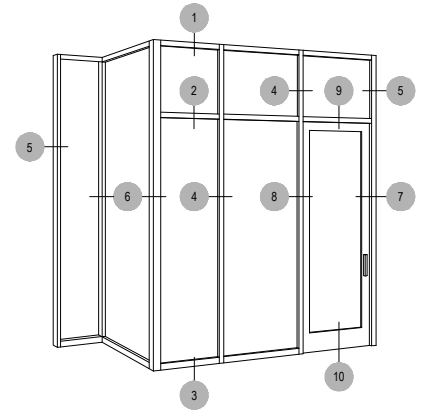
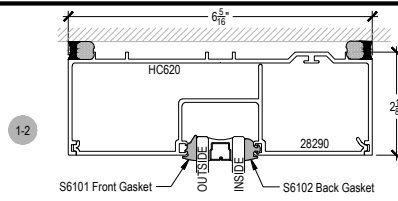
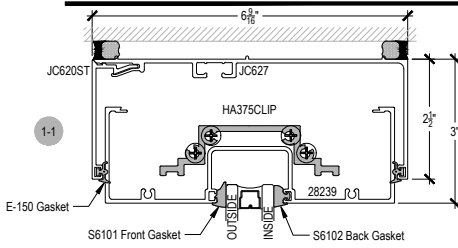

SHEAR BLOCK OUTSIDE SET

COMPENSATING STICK OUTSIDE SET

GASKET PLACEMENT FOR 1 3/8" POCKET

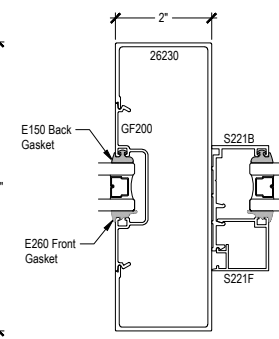
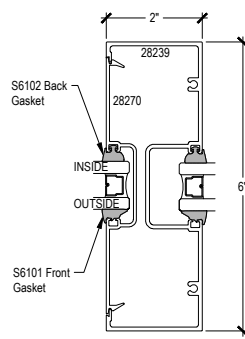
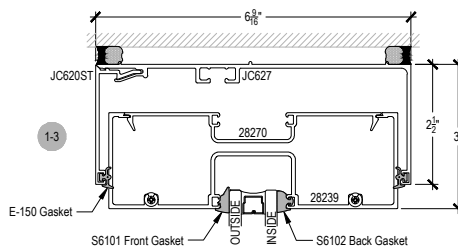
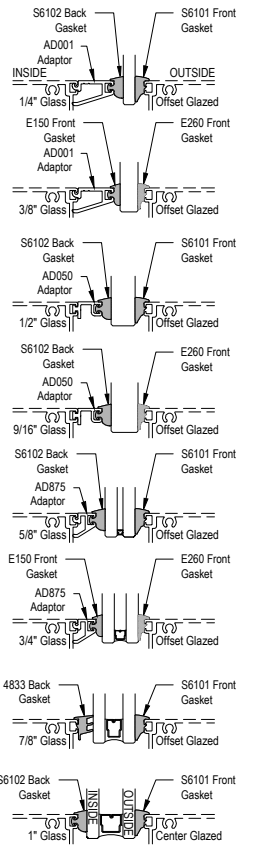

VERTICAL @ TRANSOM

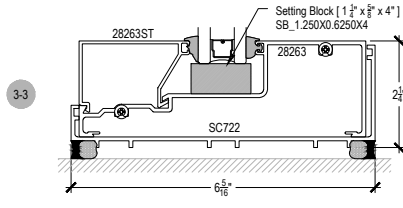
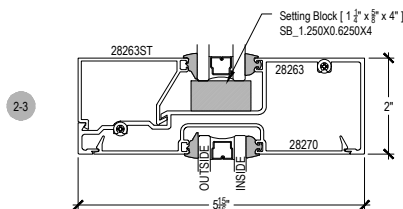

SCREW SPLINE OUTSIDE SET

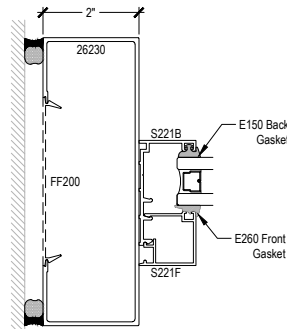
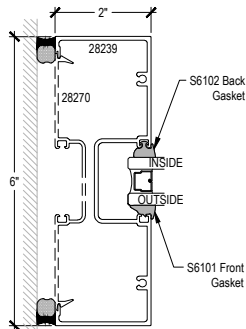

JAMB @ TRANSOM

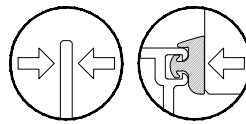

AG601 Series

Description: 2" X 6" Center Glazed For 1" Glass

Function: Window Wall

Detail: Doors

Scale: 3" = 1'-0"

SHEET 2 OF 2

