

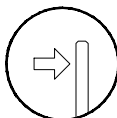

Acoustic

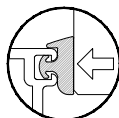

Offset Glass



Side Load

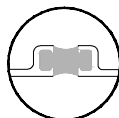

Thermal System

# T500 (OPG1928) STC Series

Description: 2 1/4" X 8 1/8" With 1 3/8" Glass

Function: Curtain Wall

Detail: Horizontals

Scale: 3" = 1'-0"

SHEET 1 OF 3

Optional Projected Cover Cap Available

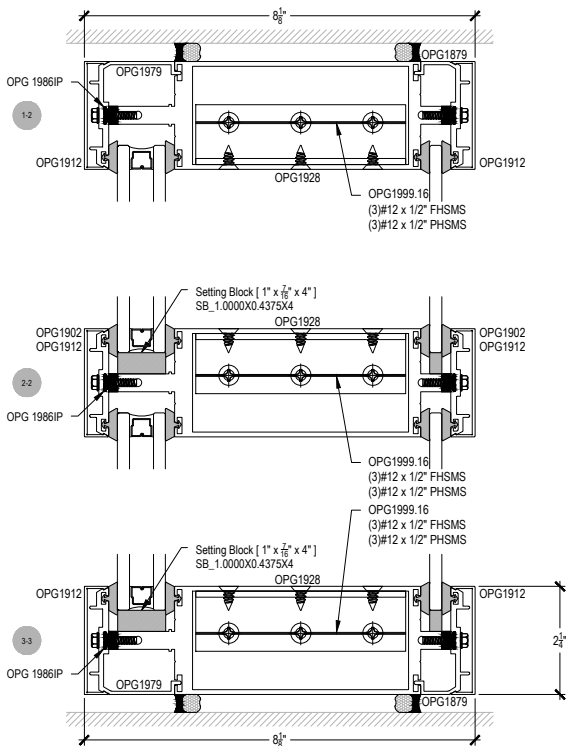
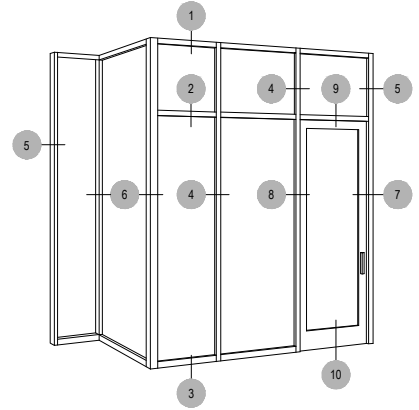
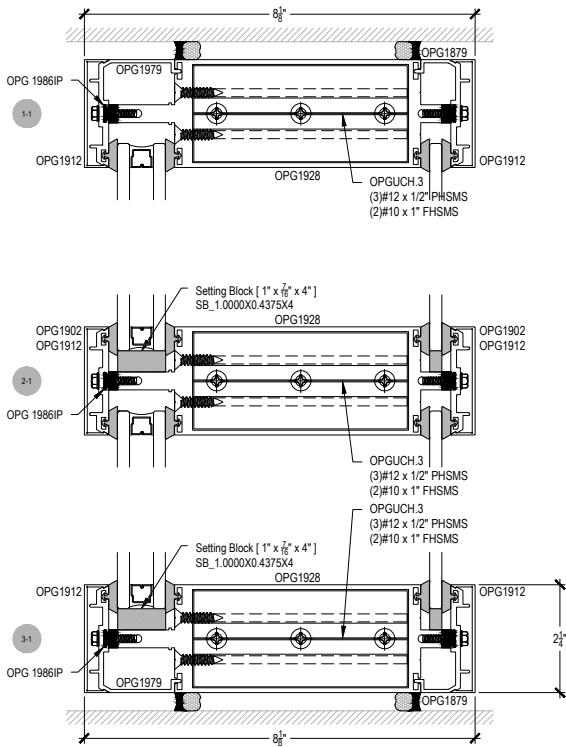

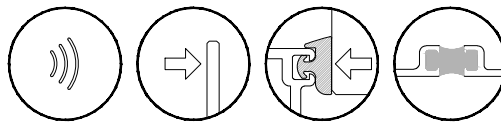

Acoustic

Offset Glass

Side Load

Thermal System

Optional Projected Cover Cap Available

# T500 (OPG1928) STC Series

Description: 2 1/4" X 8 1/8" With 1 3/8" Glass

Function: Curtain Wall

Detail: Verticals

Scale: 3" = 1'-0"

SHEET 2 OF 3

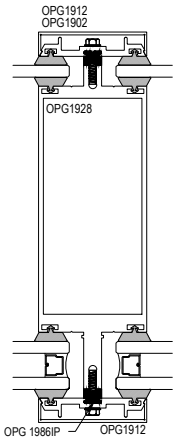
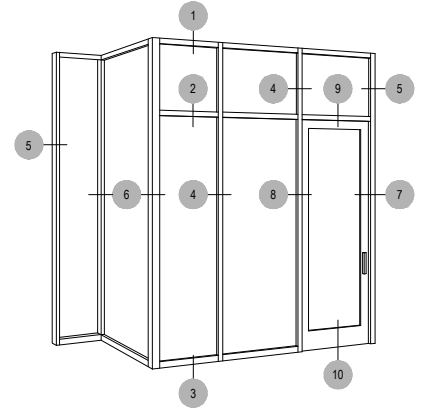

4-1

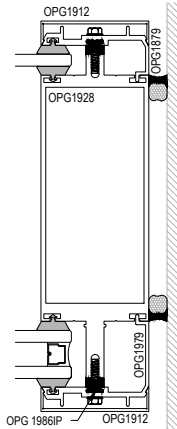

5-1

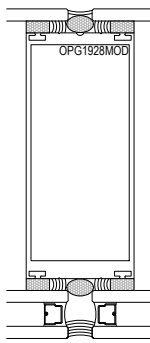

4-2

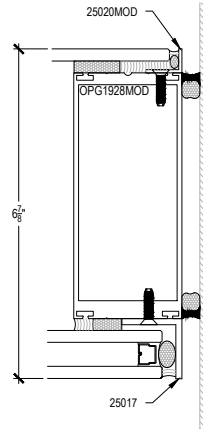

5-2

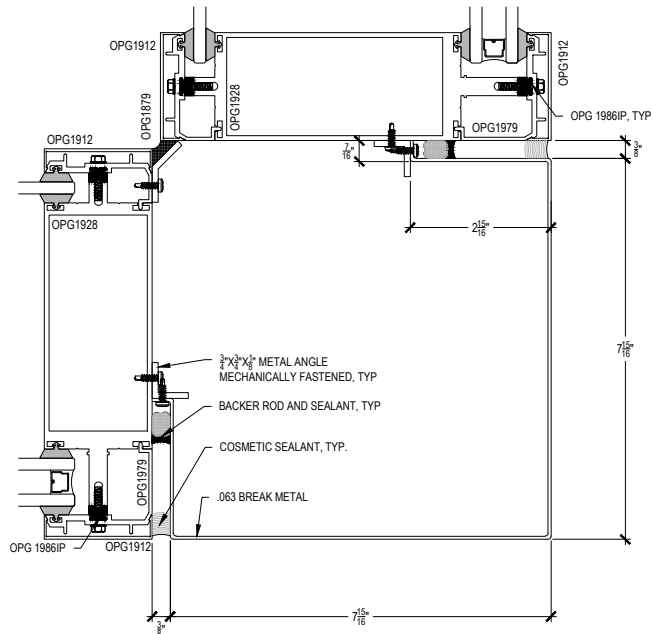

5-1

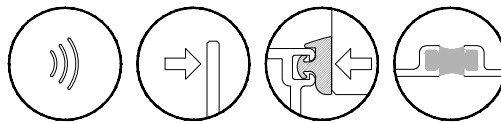

Acoustic      Offset Glass      Side Load      Thermal System

Optional Projected Cover Cap Available

# T500 (OPG1928) STC Series

Description: 2 1/4" X 8 1/8" With 1 3/8" Glass

Function: Curtain Wall

Detail: Doors

Scale: 3" = 1'-0"

SHEET 3 OF 3

