

Offset Glazed Side Load Thermal
Optional Projected Cover Cap Available

T500 (OPG3800) Series

Description: 2 1/4" X 10" With 1/4" - 3/8" Glass

Function: Curtain Wall

Detail: Horizontals, Verticals

Scale: 3" = 1'-0"

SHEET 1 OF 3

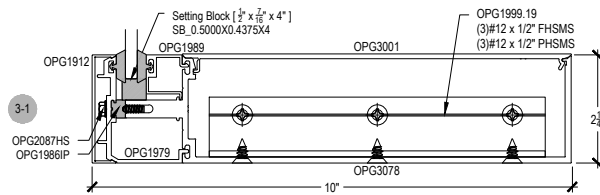
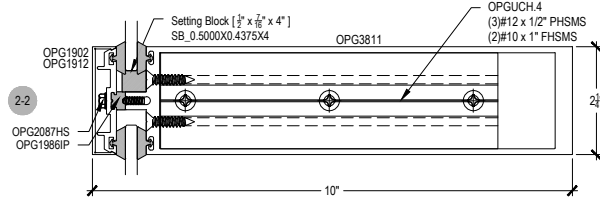
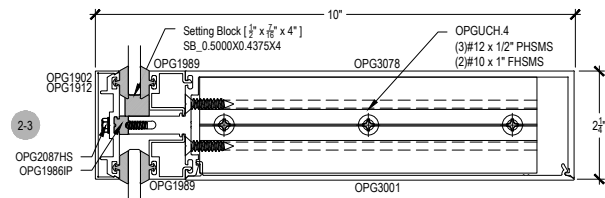
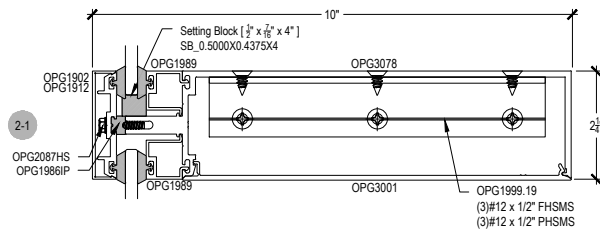
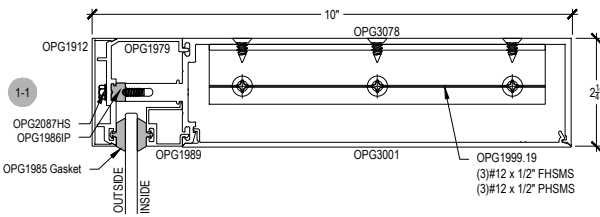
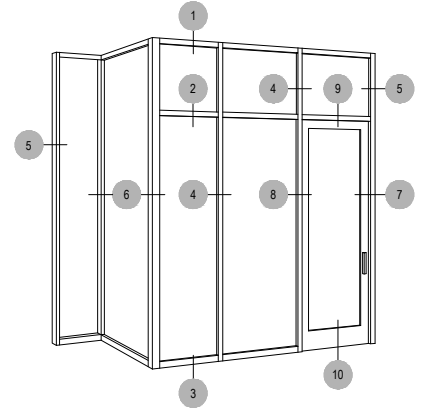
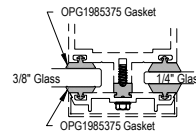

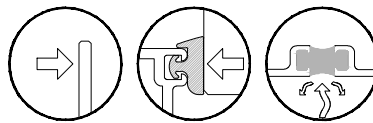

Offset Glazed Side Load Thermal
Optional Projected Cover Cap Available

T500 (OPG3800) Series

Description: 2 1/4" X 10" With 1/4" - 3/8" Glass

Function: Curtain Wall

Detail: Doors

Scale: 3" = 1'-0"

SHEET 2 OF 3

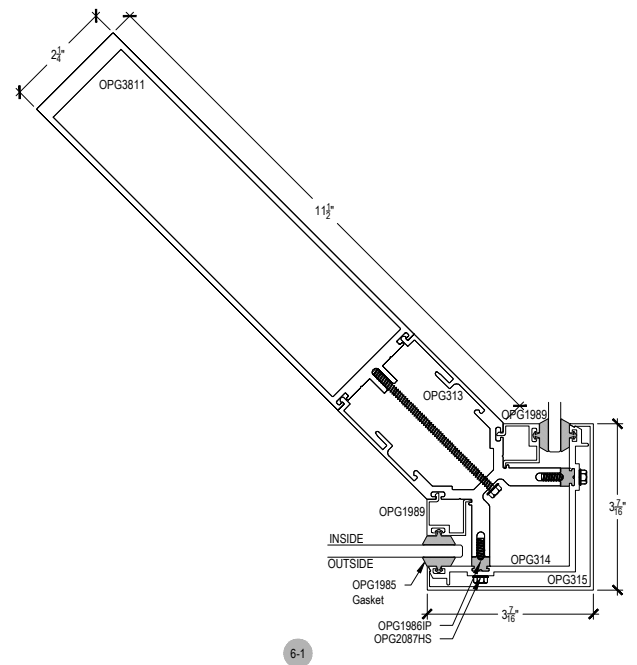
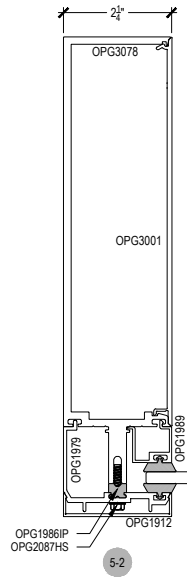
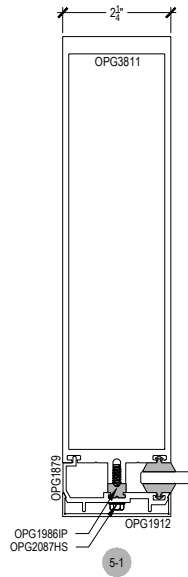
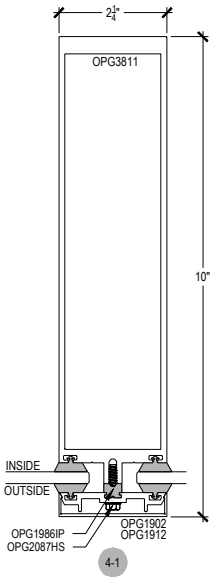
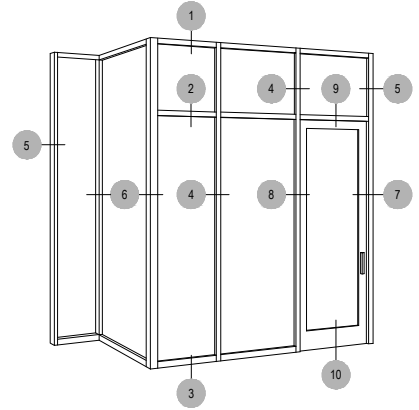
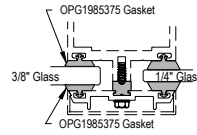

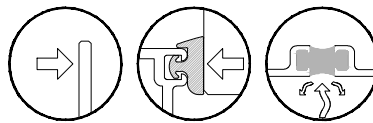

Offset Glazed Side Load Thermal
Optional Projected Cover Cap Available

T500 (OPG3800) Series

Description: 2 1/4" X 10" With 1/4" - 3/8" Glass

Function: Curtain Wall

Detail: Doors

Scale: 3" = 1'-0"

SHEET 3 OF 3

