

Offset Glazed

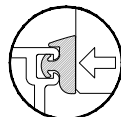

Side Load

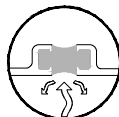

Thermal

# UW2581 Series

Description: 2 1/2" X 8 5/8" Offset Glazed For 1" Glass

Function: Unitized Wall System

Detail: Horizontals

Scale: 3" = 1'-0"

SHEET 1 OF 3

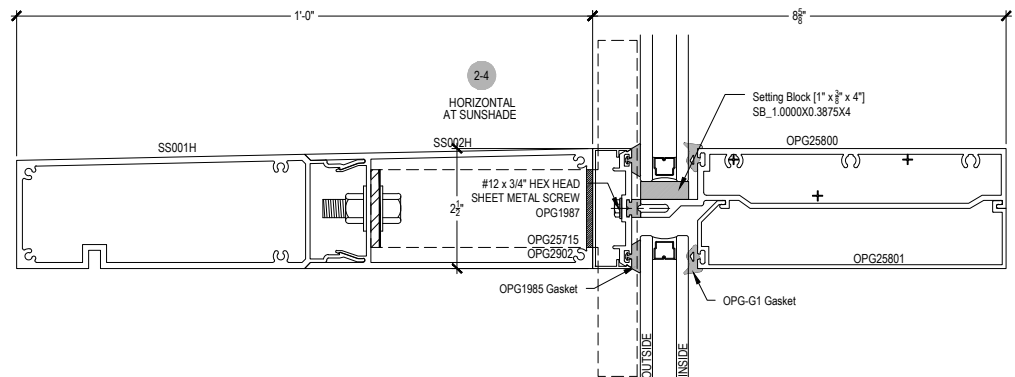
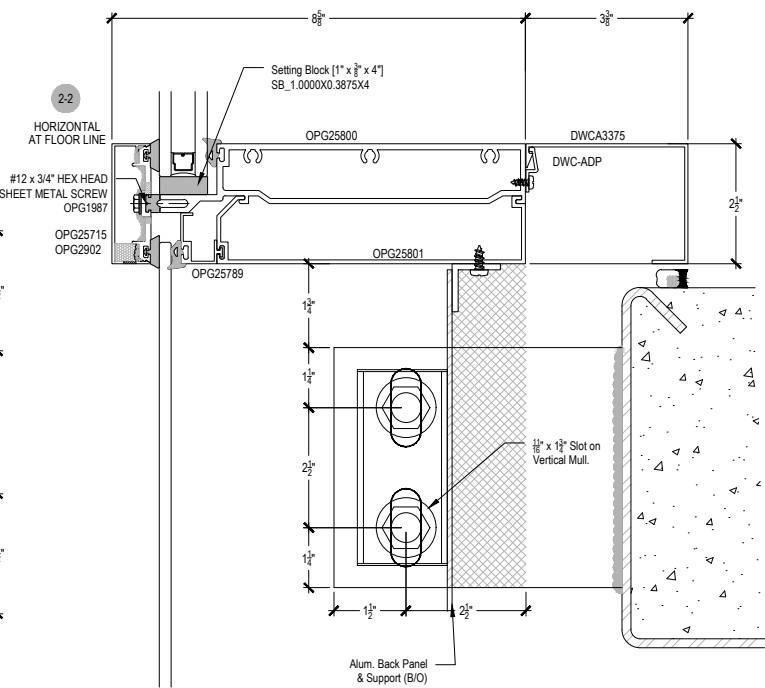
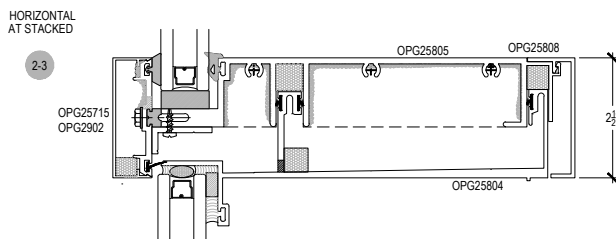
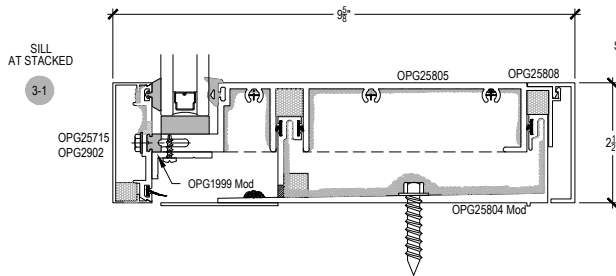
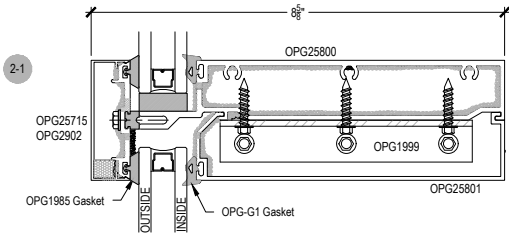
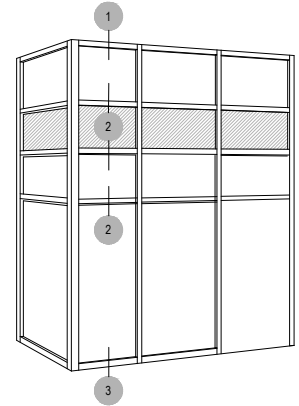
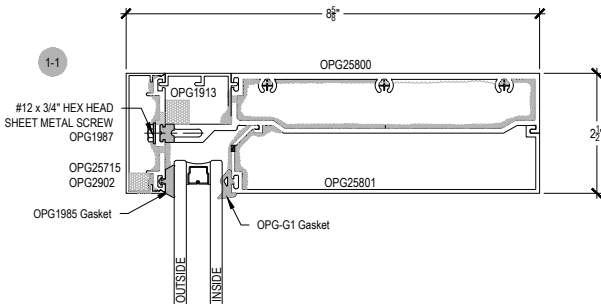

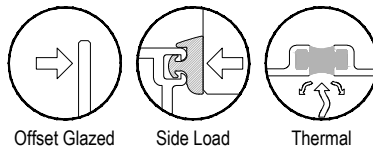

# UW2581 Series

Description: 2 1/2" X 8 5/8" Offset Glazed For 1" Glass

Function: Unitized Wall System

Detail: Verticals

Scale: 3" = 1'-0"

SHEET 2 OF 3

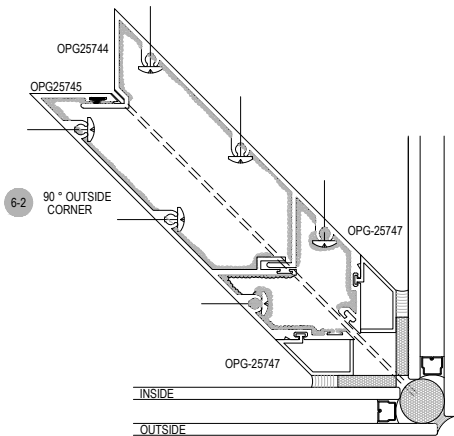
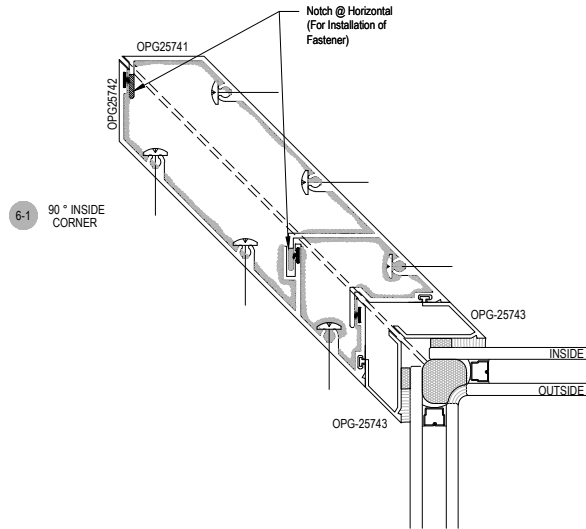
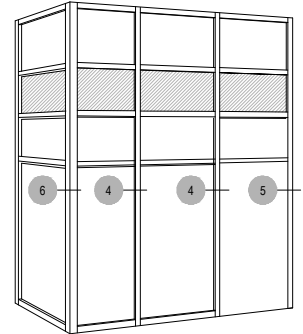
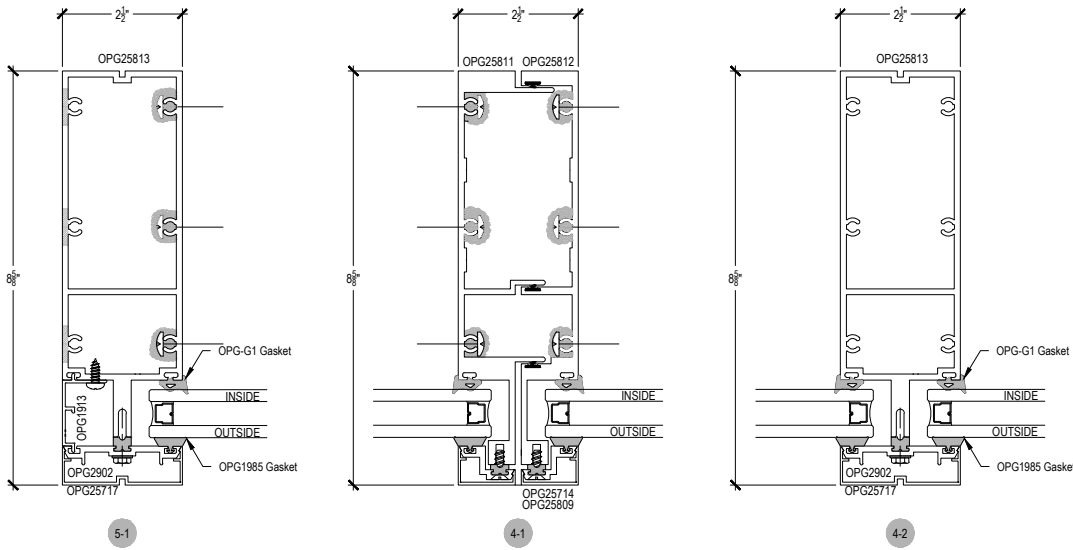

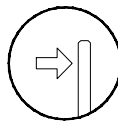

Offset Glazed

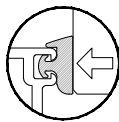

Side Load

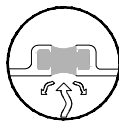

Thermal

# UW2581 Series

Description: 2 1/2" X 8 5/8" Offset Glazed For 1" Glass

Function: Unitized Wall System

Detail: Doors

Scale: 3" = 1'-0"

SHEET 3 OF 3

