



Acoustic



Casement



Hopper



Awning

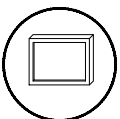

Fixed

T200 STC Series

Description: Heavy Commercial window (Outside Set)

Function: Acoustical - Hung Window - (STC-34 to 38)

Detail: Fixed, Casement, Awning, Hopper

Scale: 3" = 1'-0"

SHEET 1 OF 5

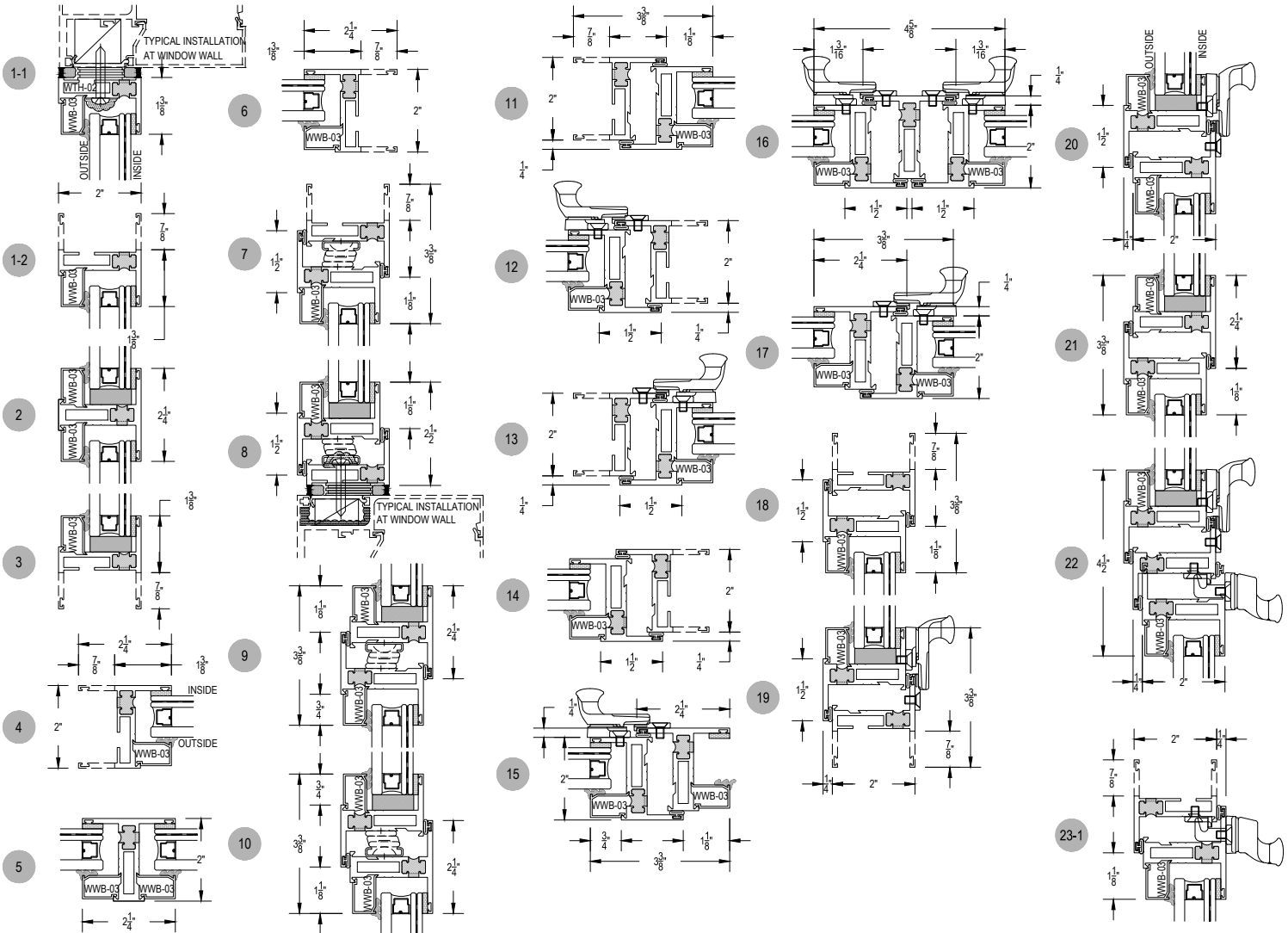
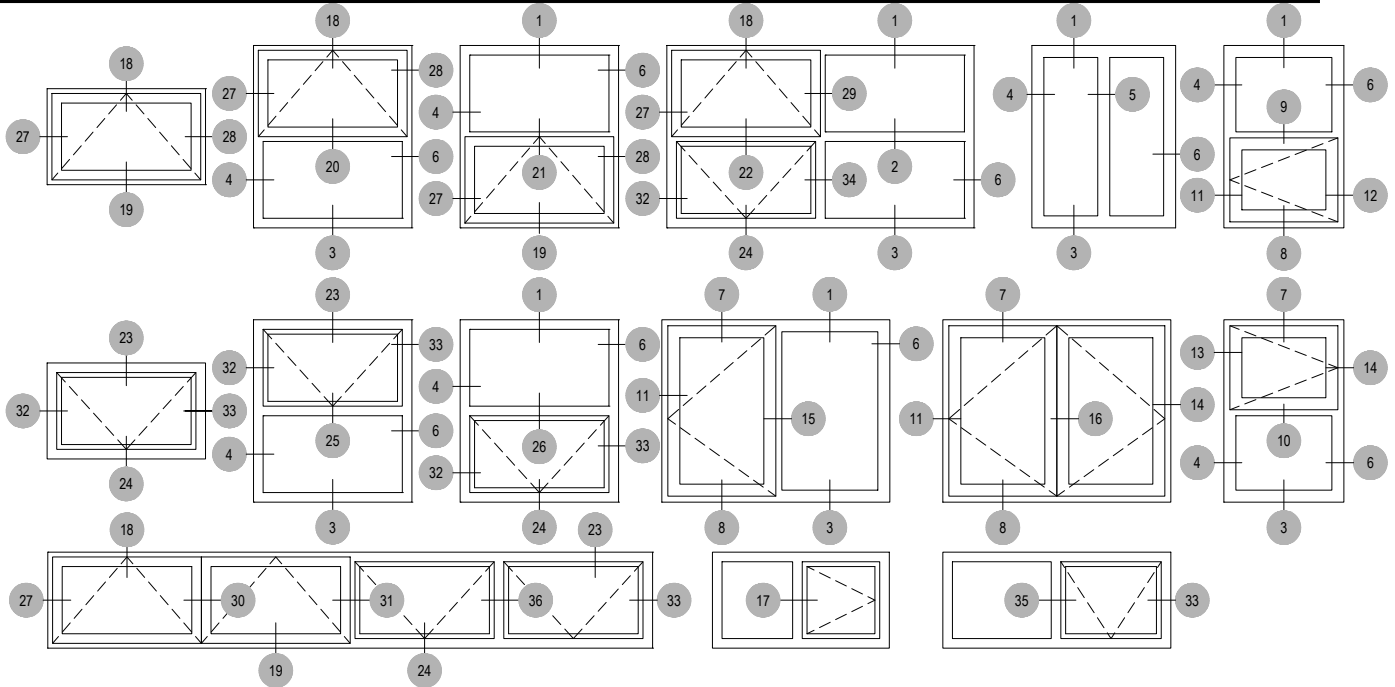



Acoustic



Casement



Hopper



Awning

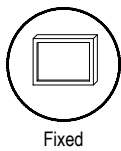

Fixed

T200 STC Series

Description: Heavy Commercial window (Outside Set)

Function: Acoustical - Hung Window - (STC-34 to 38)

Detail: Fixed, Casement, Awning, Hopper

Scale: 3" = 1'-0"

SHEET 2 OF 5

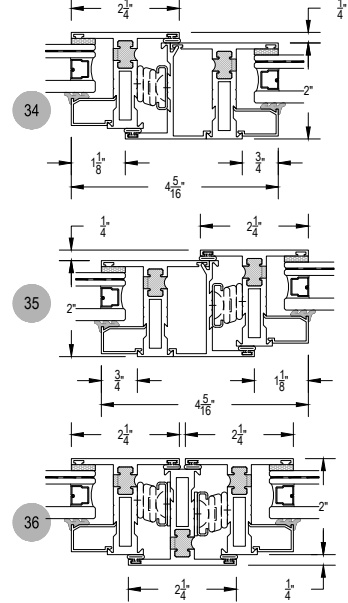
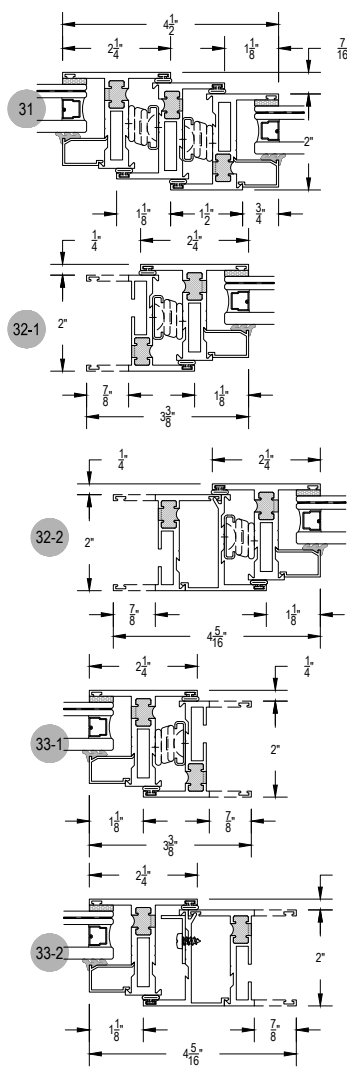
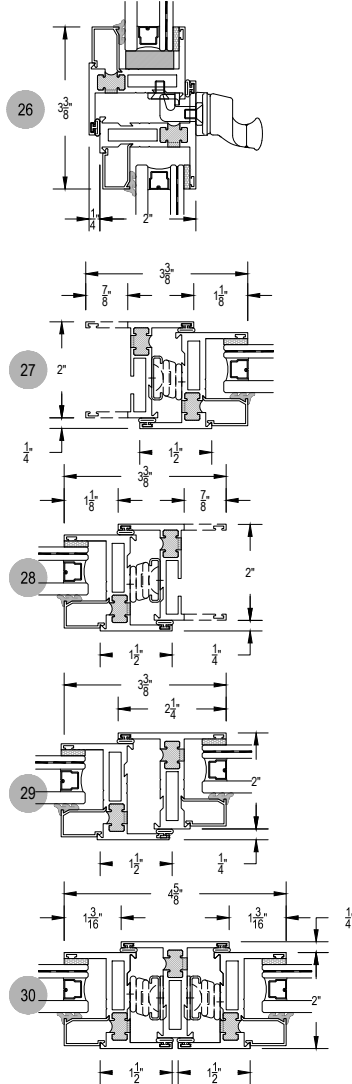
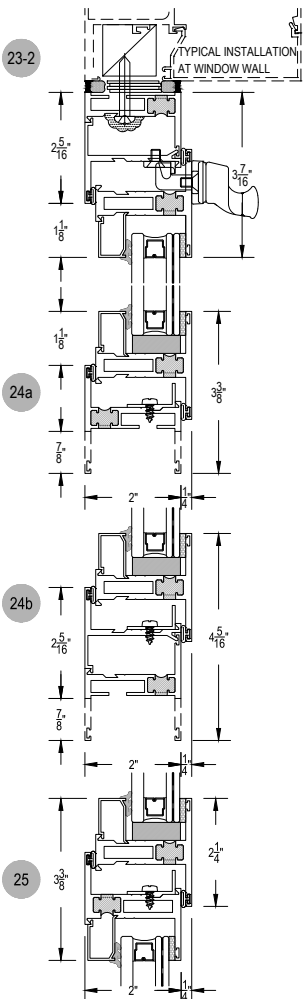
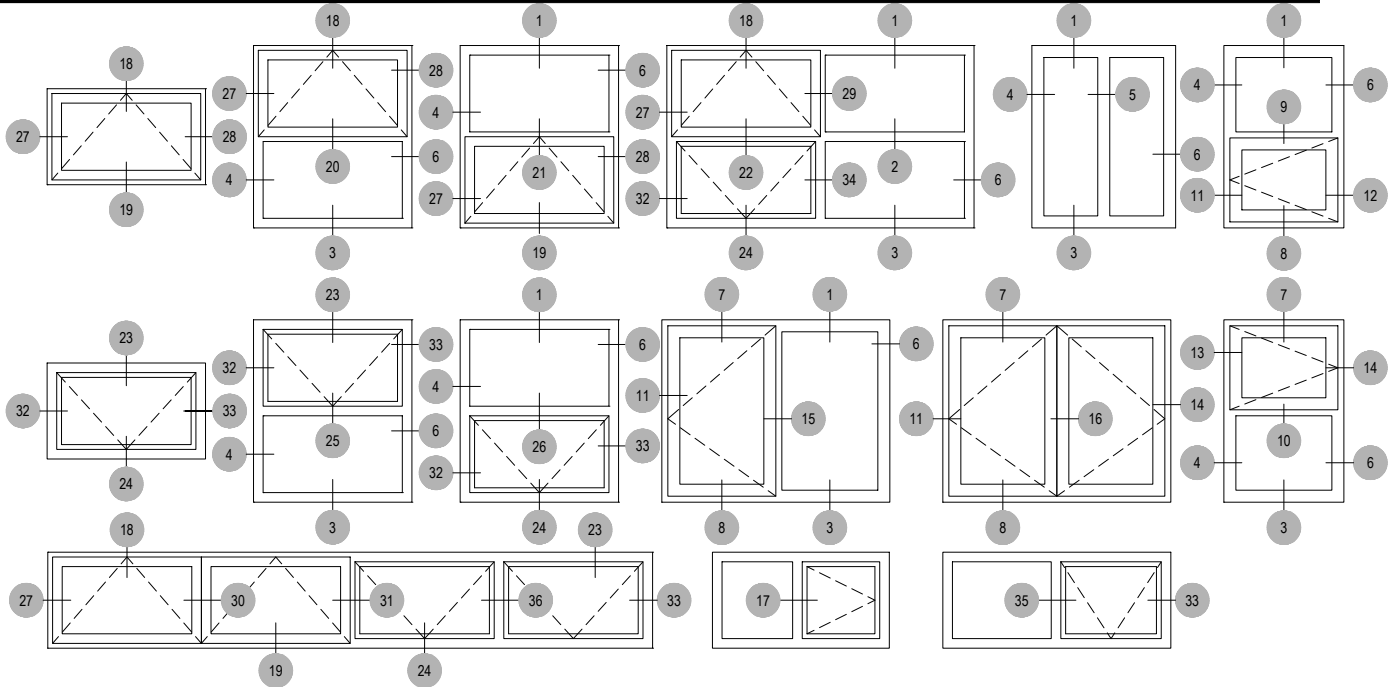



Acoustic



Casement



Hopper



Awning

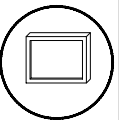

Fixed

T200 STC Series

Description: Heavy Commercial window (Inside Set)

Function: Acoustical - Hung Window - (STC-34 to 38)

Detail: Fixed, Casement, Awning, Hopper

Scale: 3" = 1'-0"

SHEET 3 OF 5

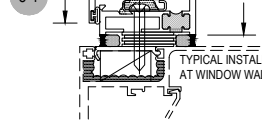
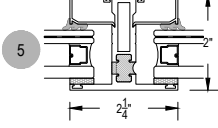
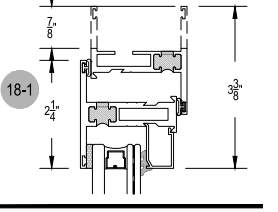
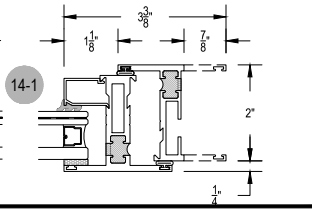
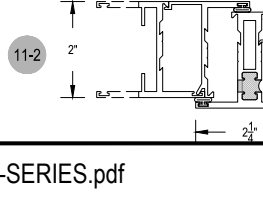
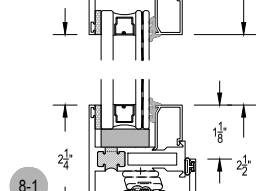
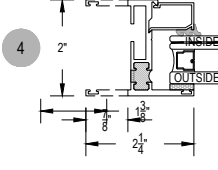
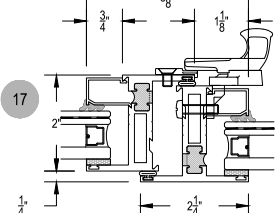
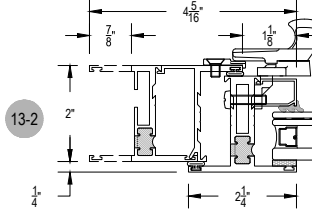
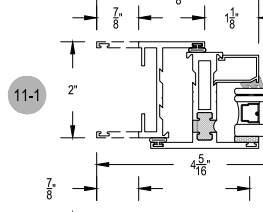
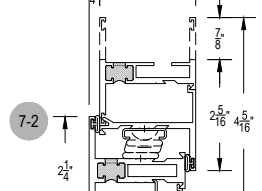
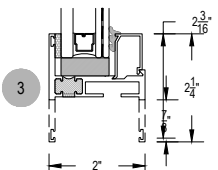
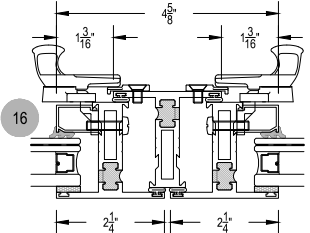
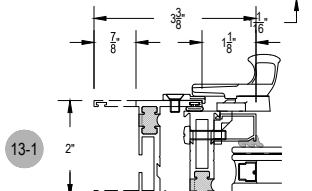
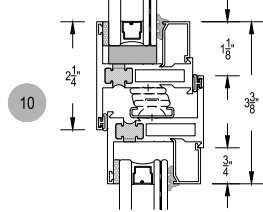
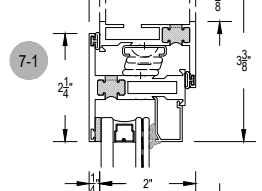
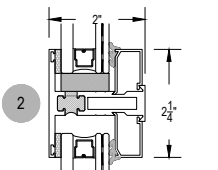
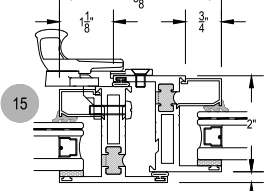
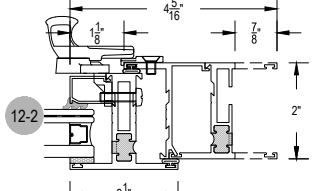
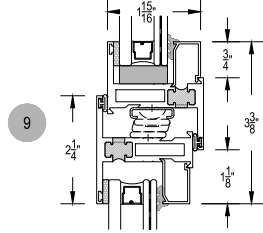
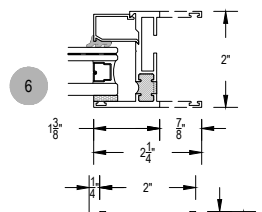
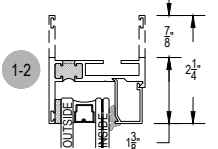
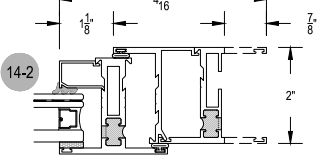
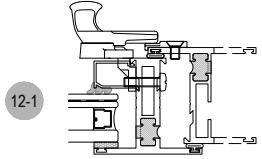
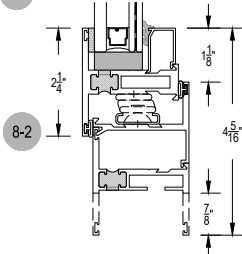
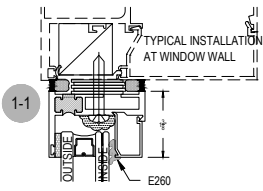
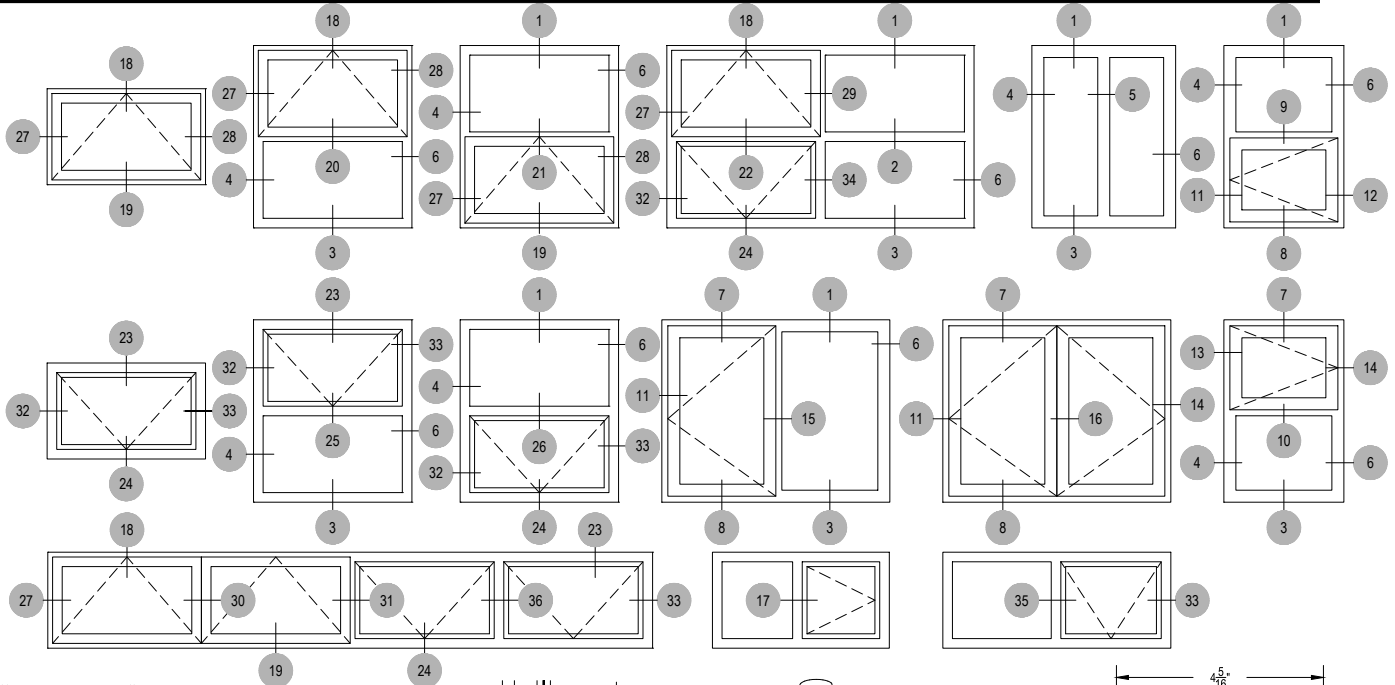



Acoustic



Casement

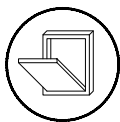

Hopper



Awning

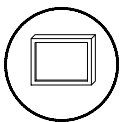

Fixed

T200 STC Series

Description: Heavy Commercial window (Inside Set)

Function: Acoustical - Hung Window - (STC-34 to 38)

Detail: Fixed, Casement, Awning, Hopper

Scale: 3" = 1'-0"

SHEET 4 OF 5

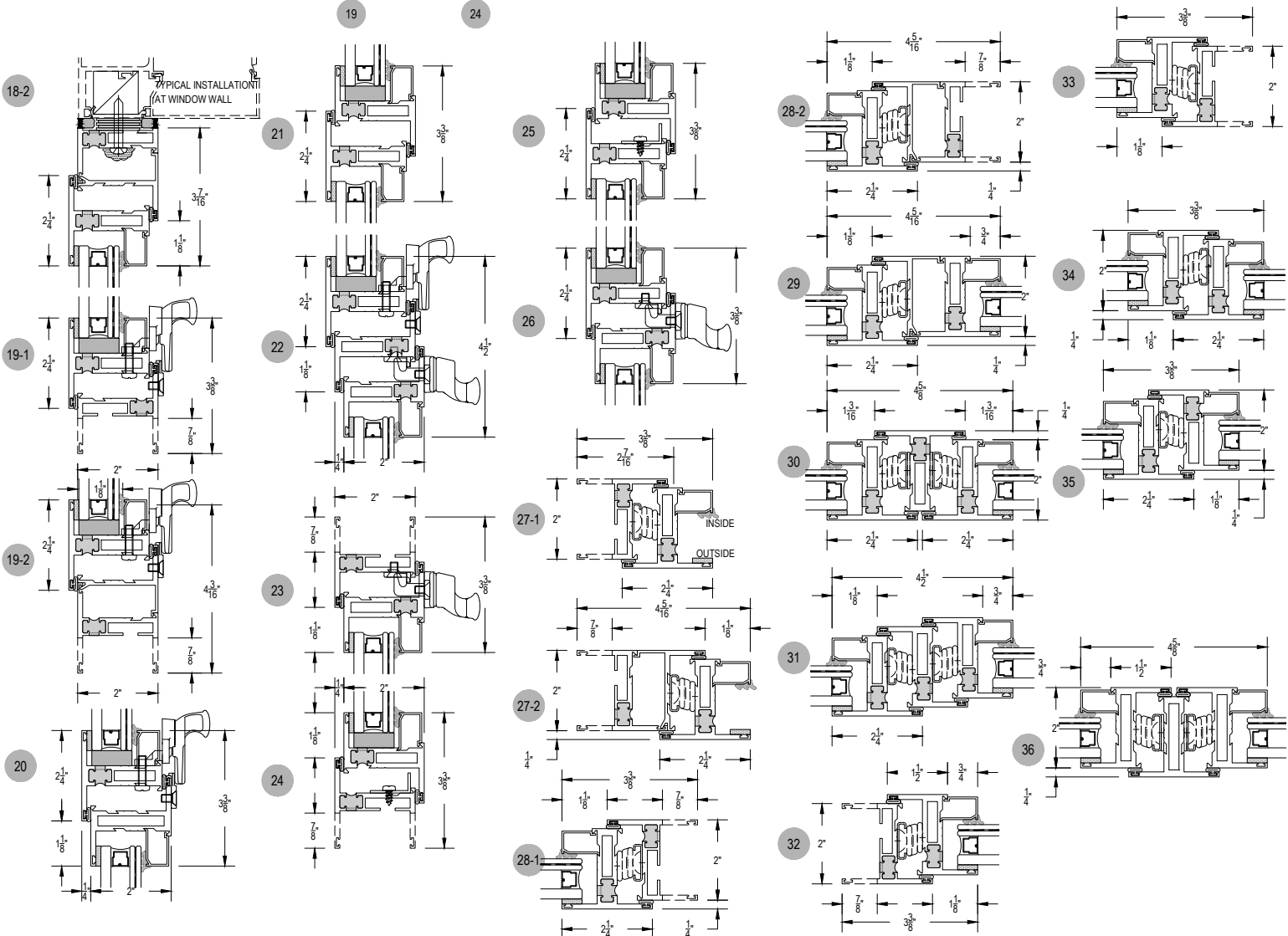
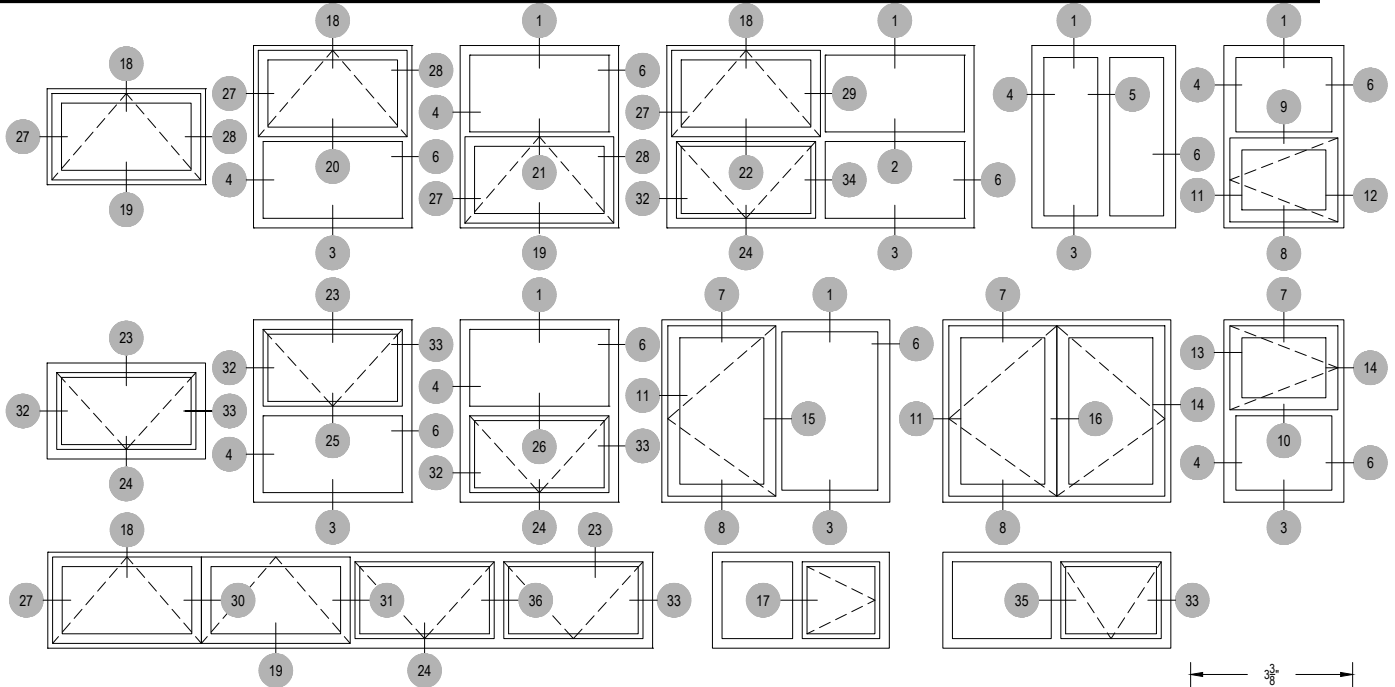

T200 Series

Description: Heavy Commercial window (Outside Set)

Function: Glazing Beads

Detail: Fixed, Casement, Awning, Hopper

Scale: 1'-0" = 1'-0" (Full)

SHEET 5 OF 5

