

Offset Glazed Side Load Thermal
Optional Projected Cover Cap Available

T500 (OPG6000) Series

Description: 2 1/4" X 6" With 1/4" - 1 1/8" Glass

Function: Curtain Wall

Detail: Horizontals

Scale: 3" = 1'-0"

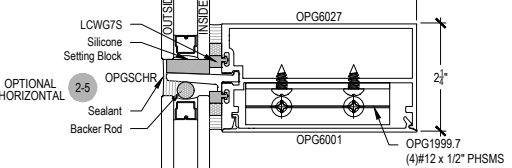
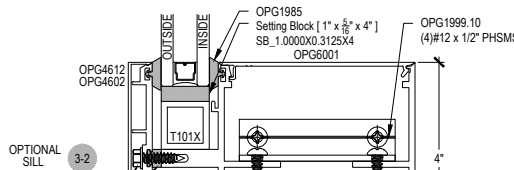
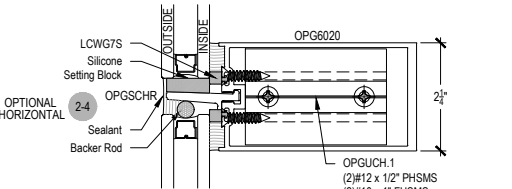
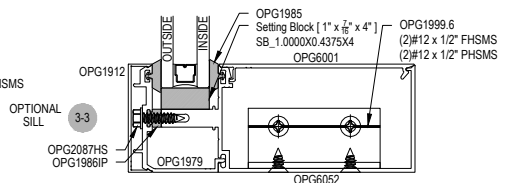
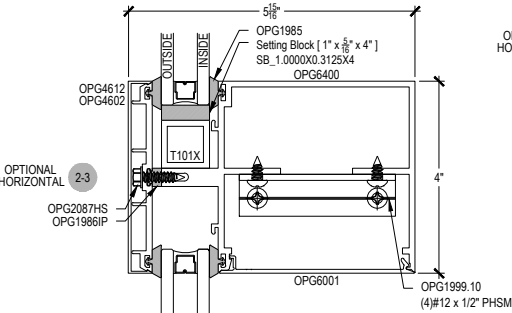
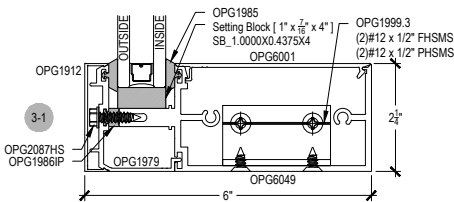
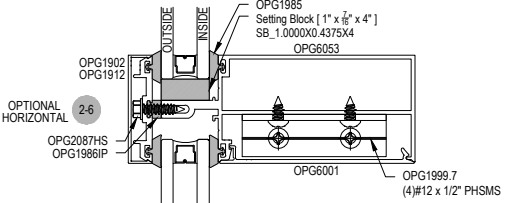
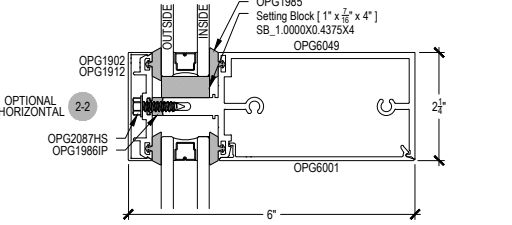
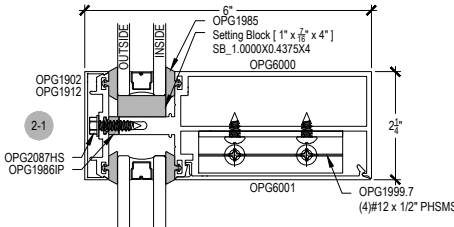
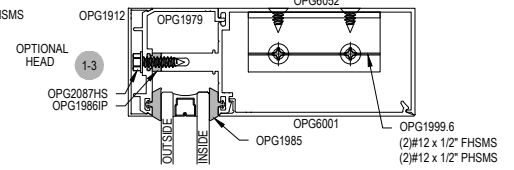
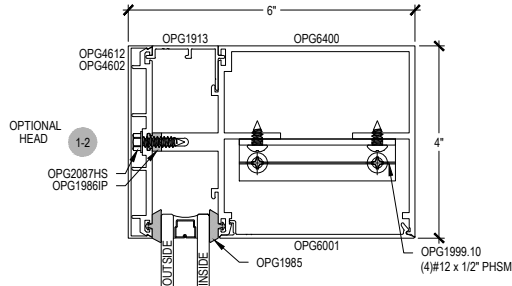
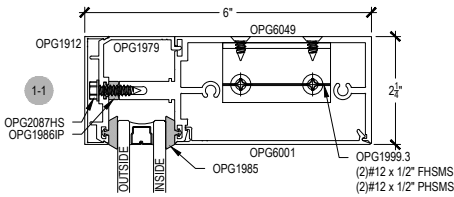
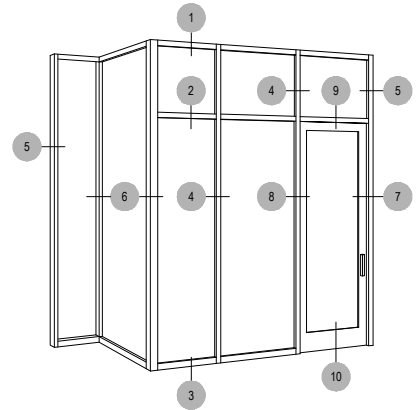
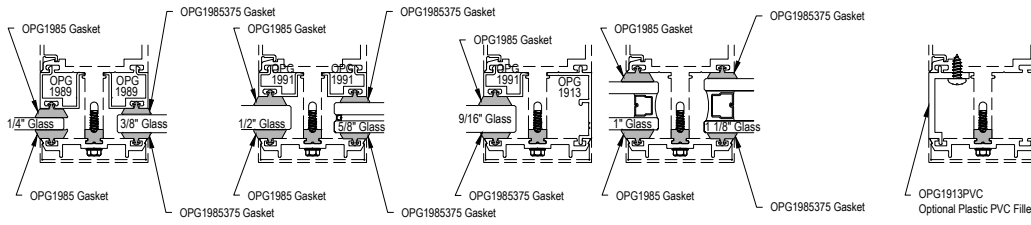

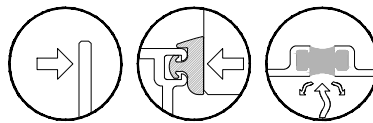

Offset Glazed Side Load Thermal
Optional Projected Cover Cap Available

T500 (OPG6000) Series

Description: 2 1/4" X 6" With 1/4" - 1 1/8" Glass

Function: Curtain Wall

Detail: Verticals

Scale: 3" = 1'-0"

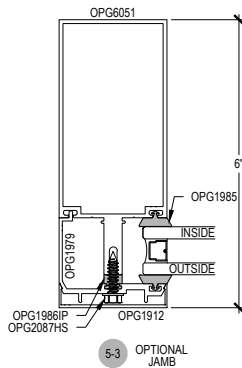
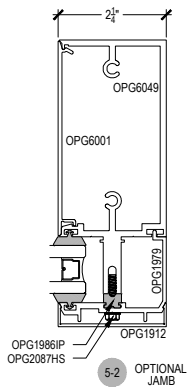
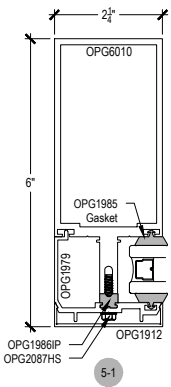
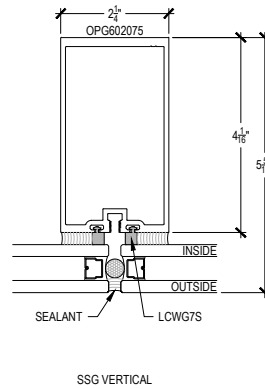
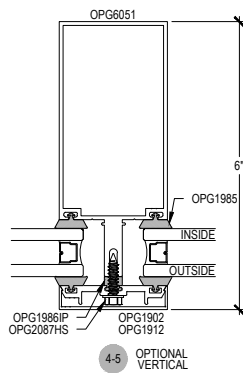
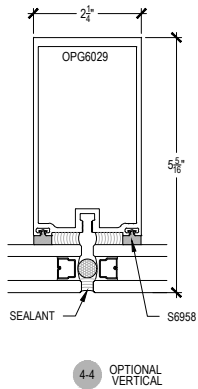
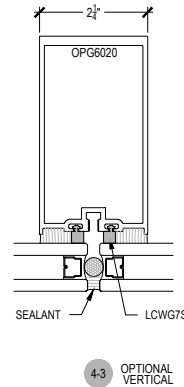
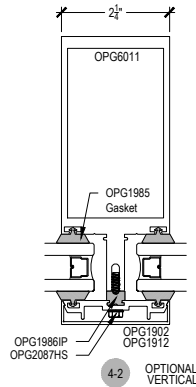
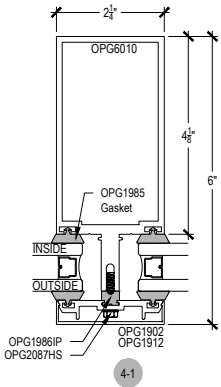
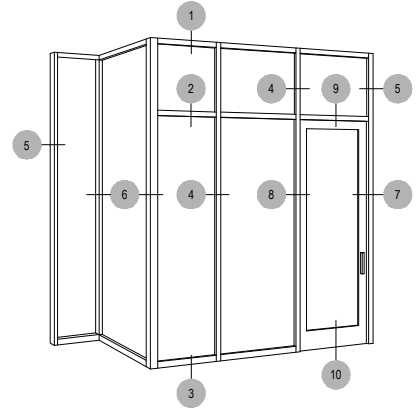
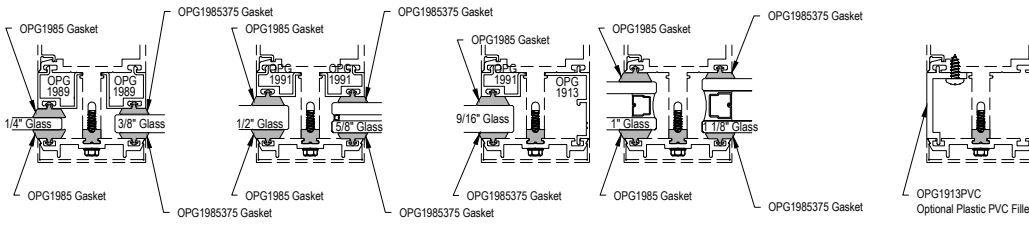

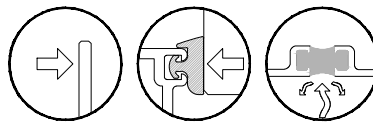

Offset Glazed Side Load Thermal
Optional Projected Cover Cap Available

T500 (OPG6000) Series

Description: 2 1/4" X 6" With 1/4" - 1 1/8" Glass

Function: Curtain Wall

Detail: Corners

Scale: 3" = 1'-0"

SHEET 3 OF 4

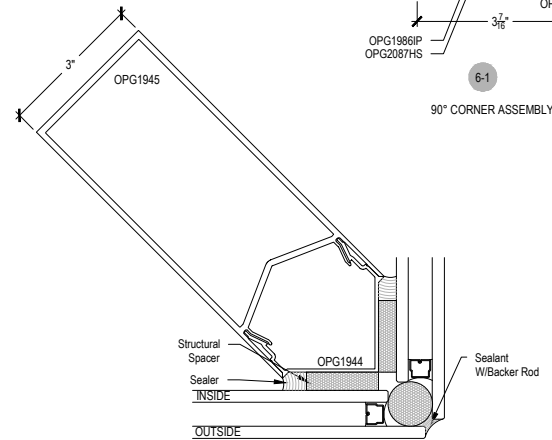
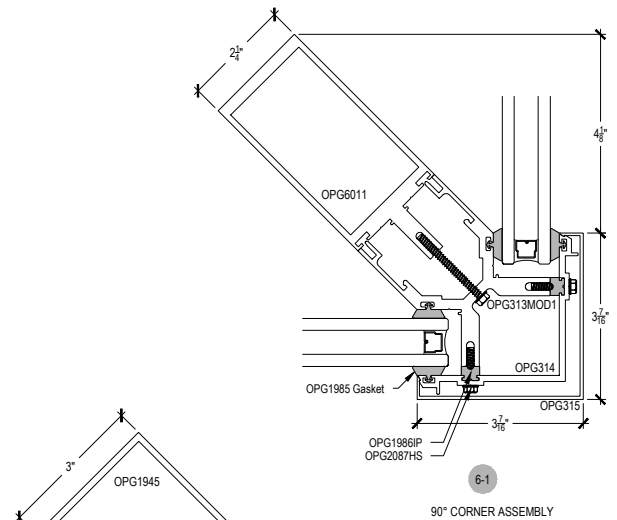
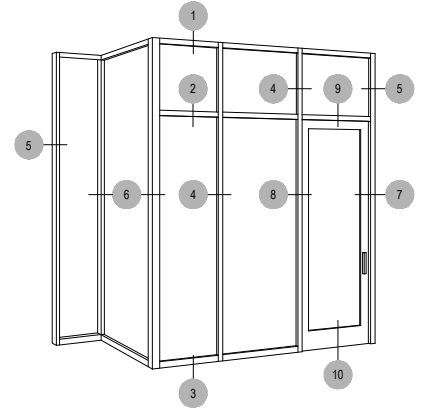
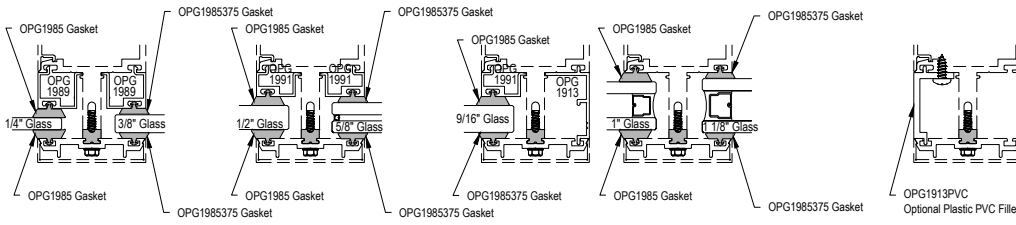

6-2
90° CORNER ASSEMBLY

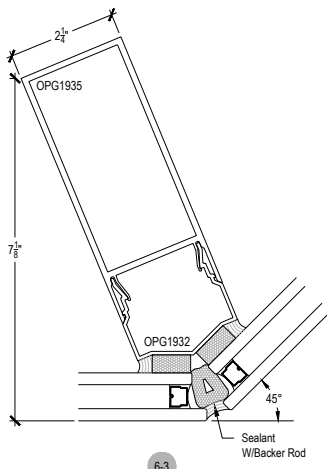

6-3
135° CORNER ASSEMBLY

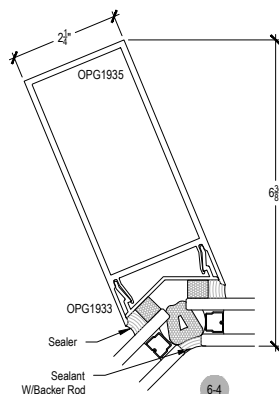

6-4
135° CORNER ASSEMBLY

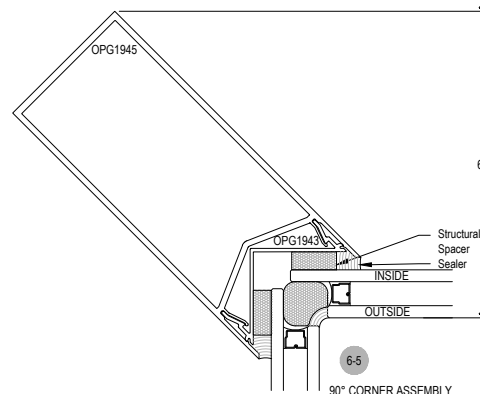

6-5
90° CORNER ASSEMBLY

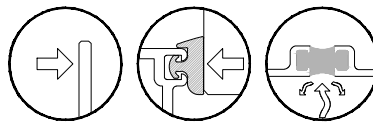

Offset Glazed Side Load Thermal
Optional Projected Cover Cap Available

T500 (OPG6000) Series

Description: 2 1/4" X 6" With 1/4" - 1 1/8" Glass

Function: Curtain Wall

Detail: Doors

Scale: 3" = 1'-0"

SHEET 4 OF 4

