

Offset Glazed Side Load Thermal
Optional Projected Cover Cap Available

T500 (OPG2900) Series

Description: 2 1/2" X 7" With 1/4" - 1 1/8" Glass Inside Set

Function: Curtain Wall

Detail: Horizontals

Scale: 3" = 1'-0"

SHEET 1 OF 3

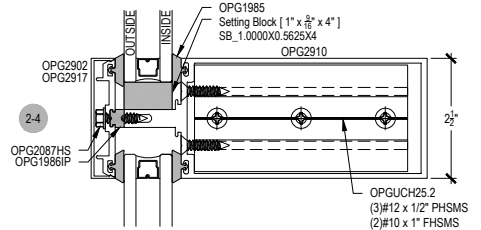
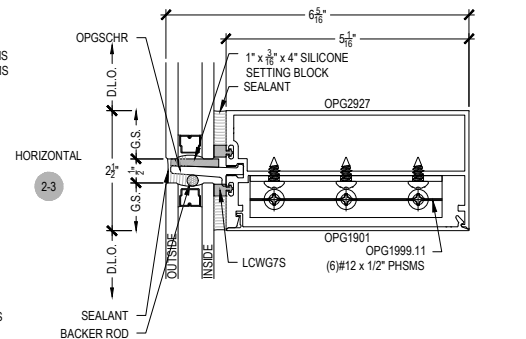
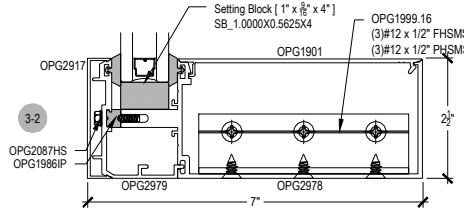
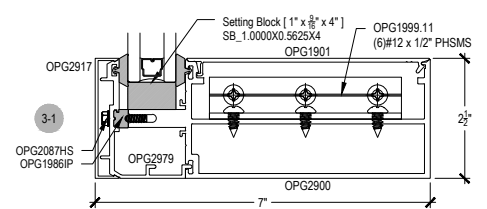
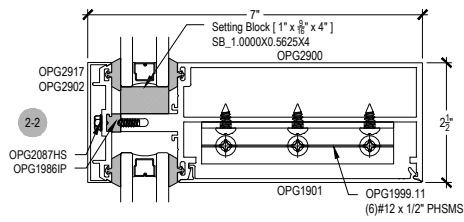
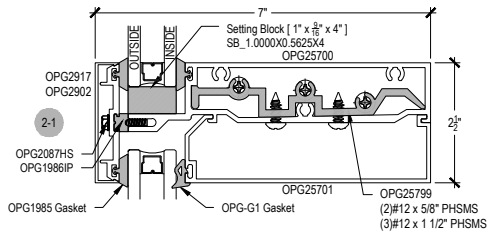
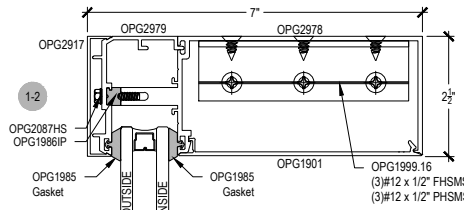
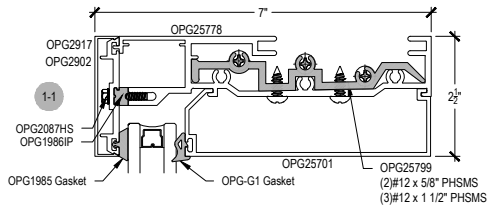
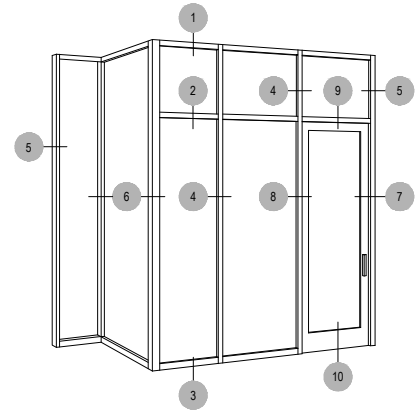
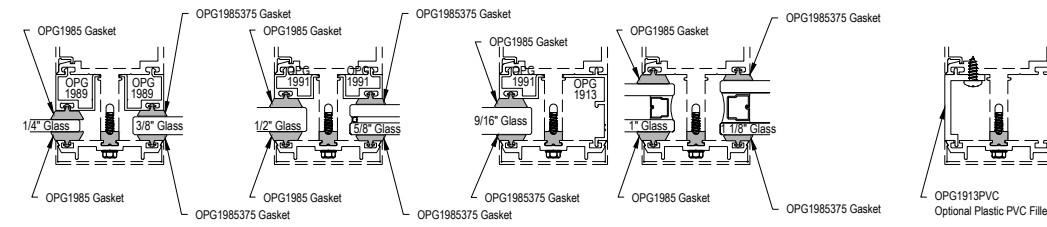

SHEAR BLOCK
INSIDE SET

SHEAR BLOCK
OUTSIDE SET

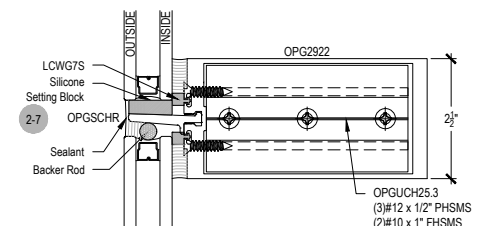
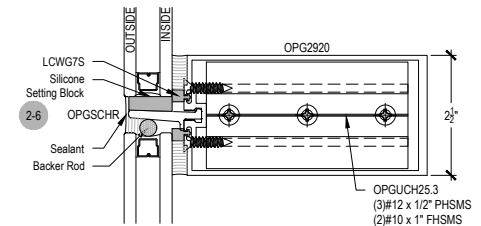
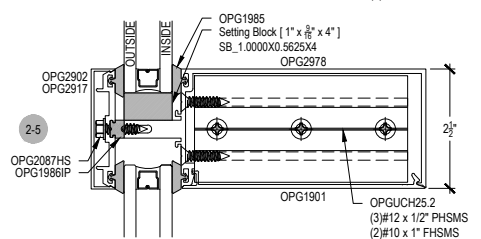

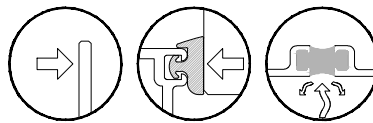

Offset Glazed

Side Load

Thermal

Optional Projected Cover Cap Available

T500 (OPG2900) Series

Description: 2 1/2" X 7" With 1/4" - 1 1/8" Glass Inside Set

Function: Curtain Wall

Detail: Verticals

Scale: 3" = 1'-0"

SHEET 2 OF 3

