

Center Glazed

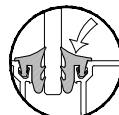

Top Load

# AG451 Series

Description: 2" x 4 1/2" Center Glazed for 1" Glass

Function: Storefront

Detail: Horizontals

Scale: 3" = 1'-0"

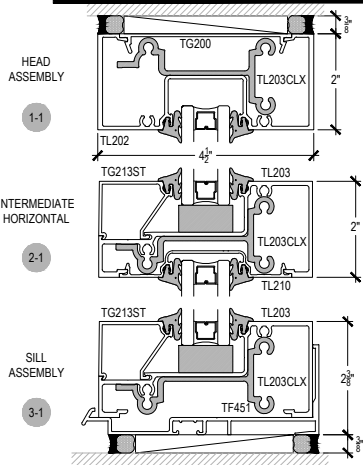

SHEAR BLOCK  
OUTSIDE SET

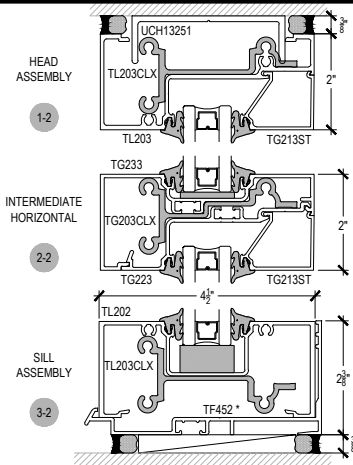

SHEAR BLOCK  
INSIDE SET

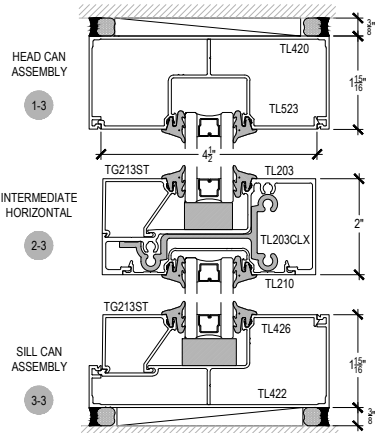

COMPENSATING STICK  
OUTSIDE SET

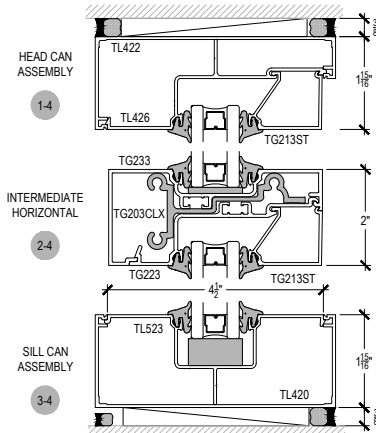

COMPENSATING STICK  
INSIDE SET

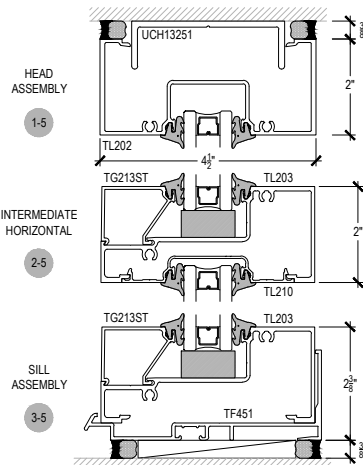

SCREW SPLINE  
OUTSIDE SET

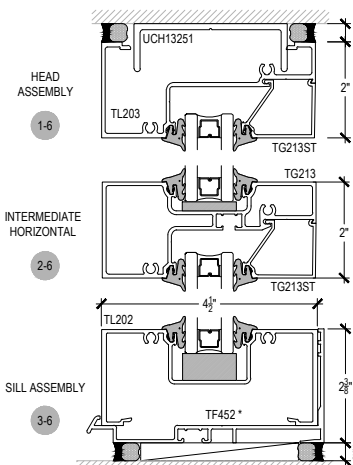

SCREW SPLINE  
INSIDE SET

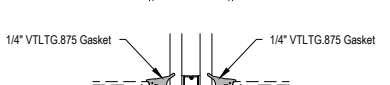
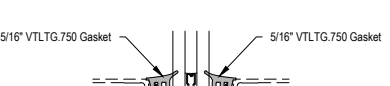
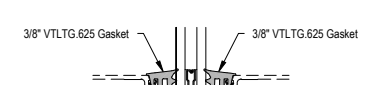
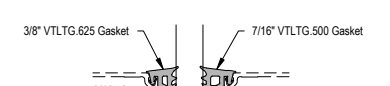
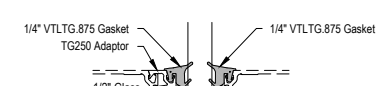
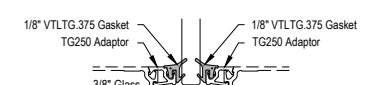
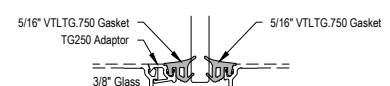
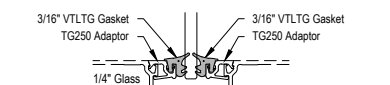
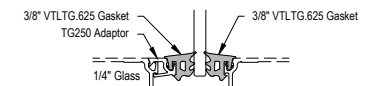
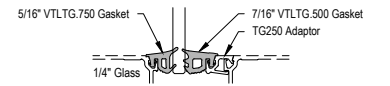
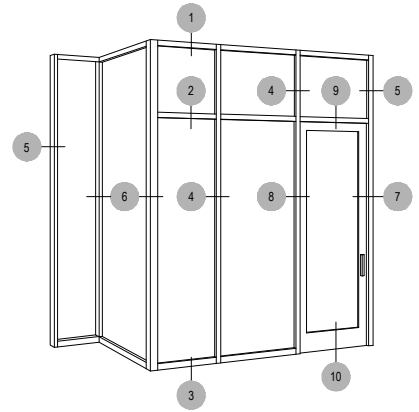

\* SPECIAL ORDER  
CALL FOR  
AVAILABILITY

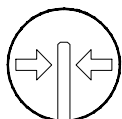

Center Glazed

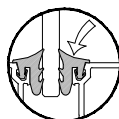

Top Load

# AG451 Series

Description: 2" x 4 1/2" Center Glazed for 1" Glass

Function: Storefront

Detail: Horizontals

Scale: 3" = 1'-0"

SHEET 2 OF 5

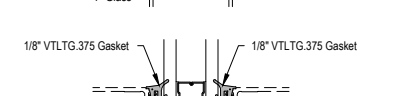
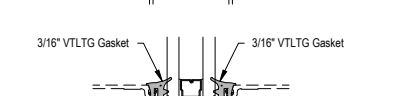
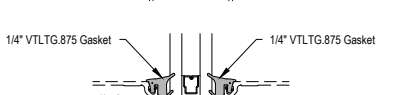
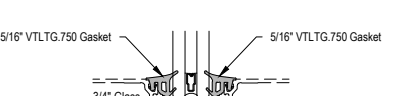
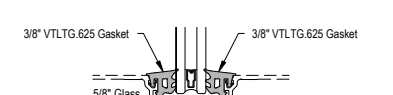
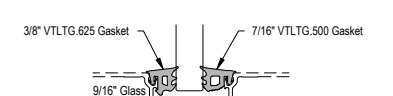
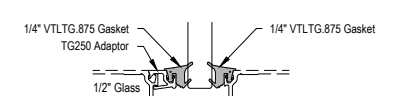
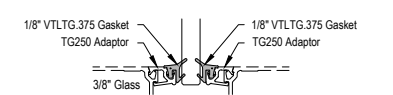
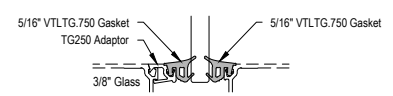
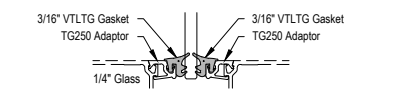
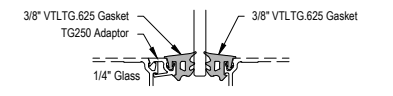
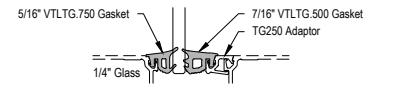
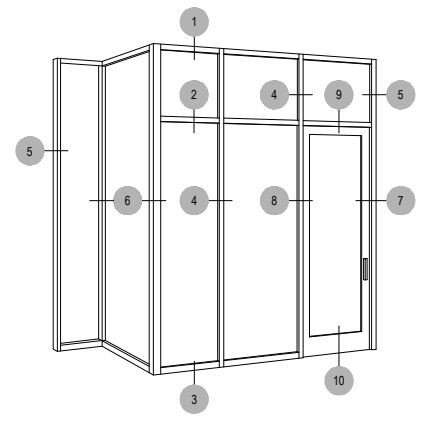
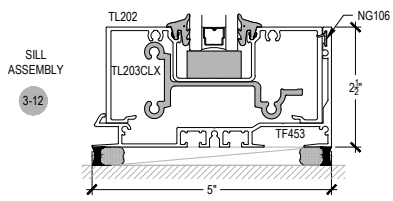
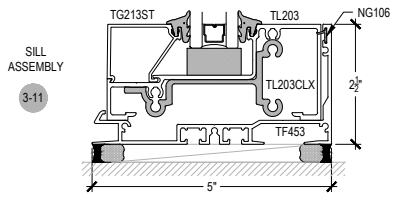
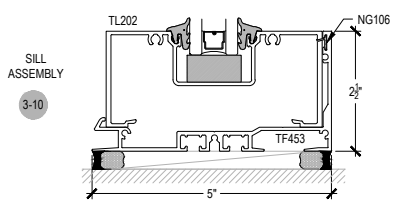
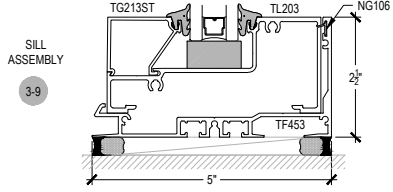
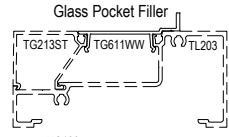
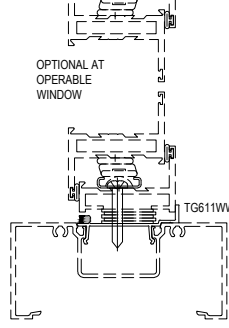
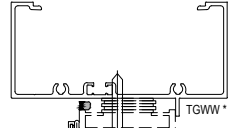
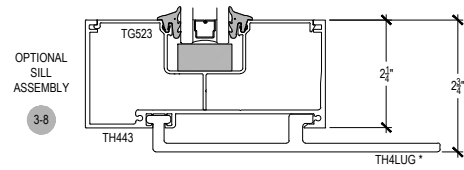
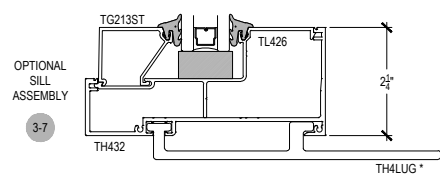
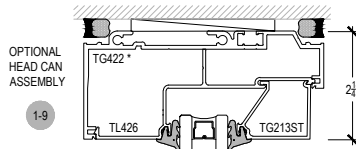
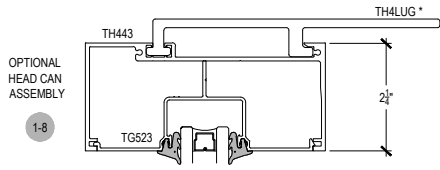
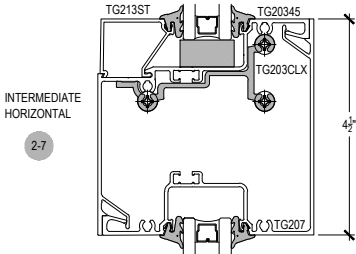
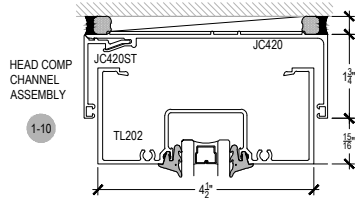
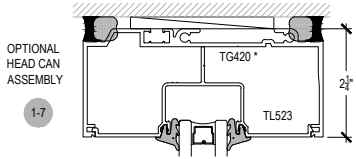

\* SPECIAL ORDER  
CALL FOR  
AVAILABILITY

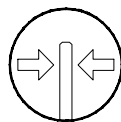

Center Glazed

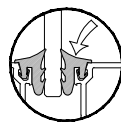

Top Load

# AG451 Series

Description: 2" x 4 1/2" Center Glazed for 1" Glass

Function: Storefront

Detail: Verticals

Scale: 3" = 1'-0"

SHEET 3 OF 5

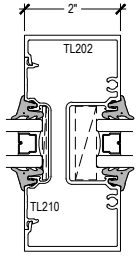

INTERMEDIATE VERTICAL

4-1

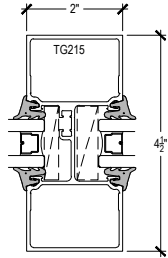

INTERMEDIATE VERTICAL

4-2

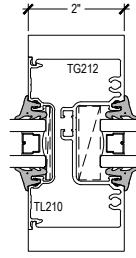

INTERMEDIATE VERTICAL

4-3

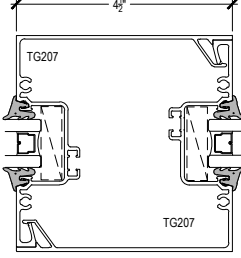

4 1/2" VERTICAL ASSEMBLY

4-4

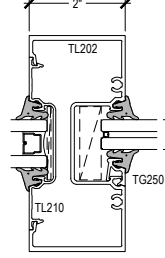

INTERMEDIATE VERTICAL w/ADAPTOR AND GLASS OPTION

4-5

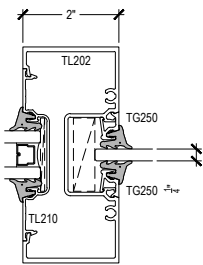
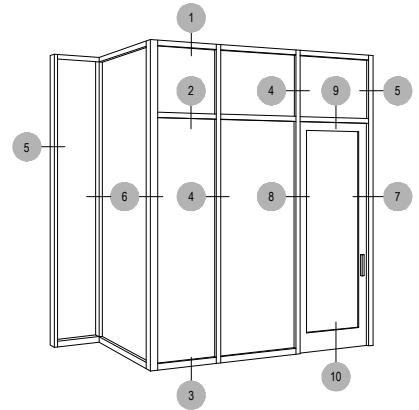

INTERMEDIATE VERTICAL w/ADAPTOR AND GLASS OPTION

4-6

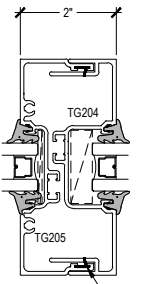

EXPANSION VERTICAL ASSEMBLY

4-7

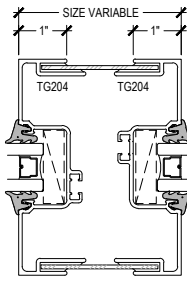

VARIABLE VERTICAL ASSEMBLY

4-8

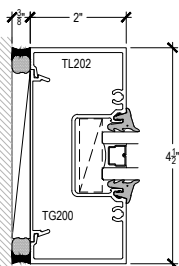
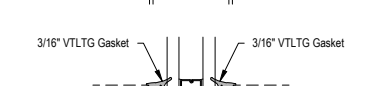
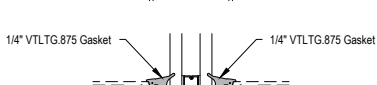
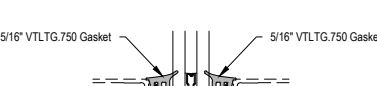
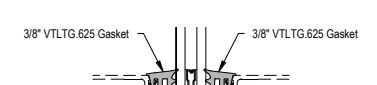
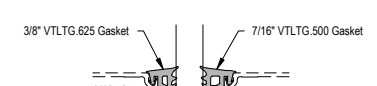
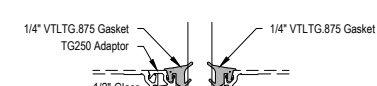
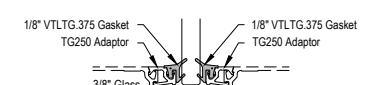
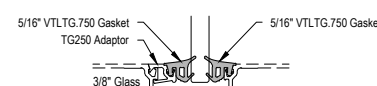
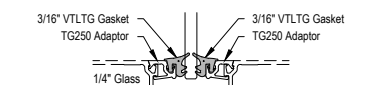
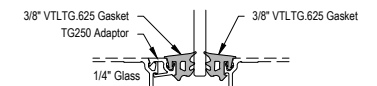
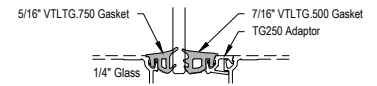

WALL JAMB

5-1

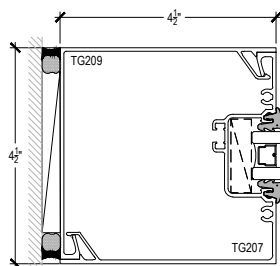

WALL JAMB ASSEMBLY

5-2

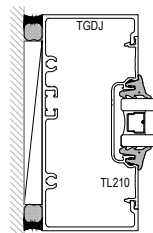

OPTIONAL JAMB

5-3

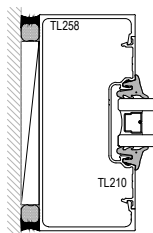

OPTIONAL JAMB

5-4

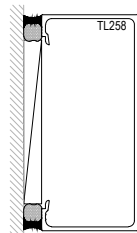

Open Back Jamb

5-5

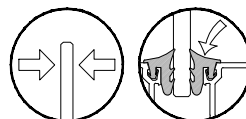

Center Glazed

Top Load

# AG451 Series

Description: 2" x 4 1/2" Center Glazed for 1" Glass

Function: Storefront

Detail: Corners

Scale: 3" = 1'-0"

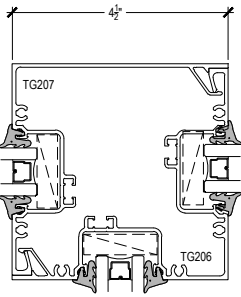

SPECIAL ASSEMBLY

6-1

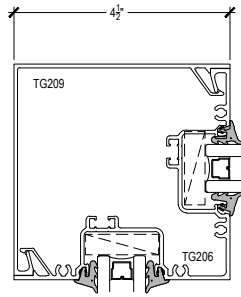

90° CORNER ASSEMBLY

6-2

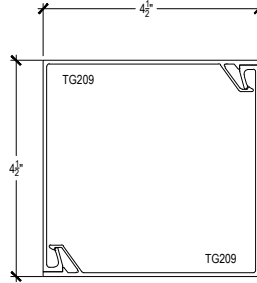

4 1/2 TUBE ASSEMBLY

6-3

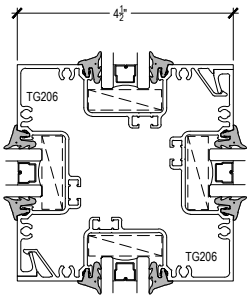
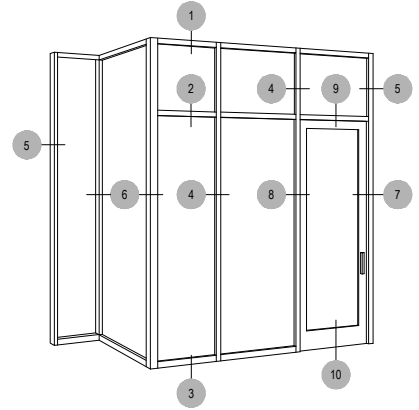

SPECIAL ASSEMBLY

6-4

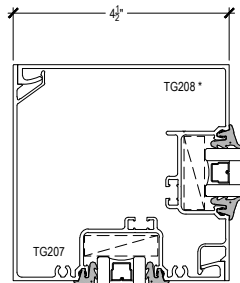

90° CORNER SCREW RACE ASSEMBLY

6-5

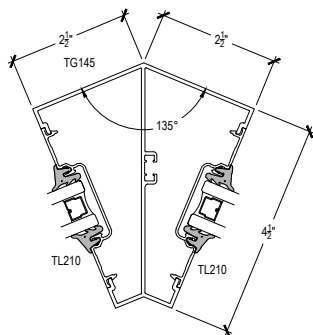
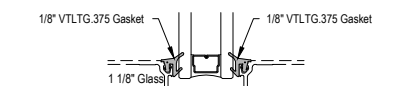
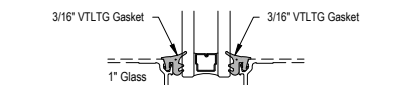
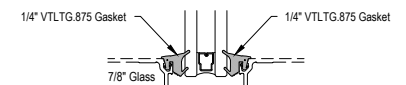
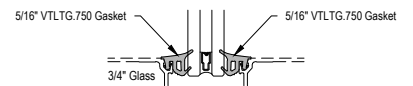
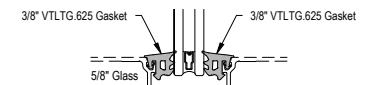
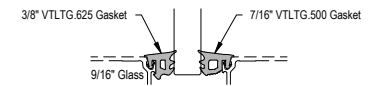
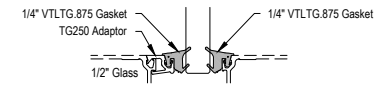
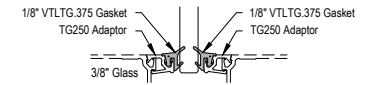
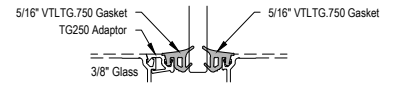
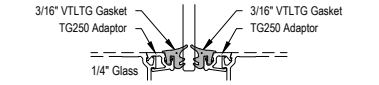
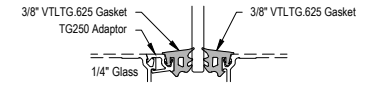
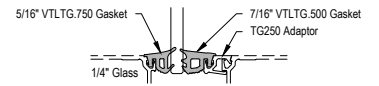

135° CORNER ASSEMBLY

6-6

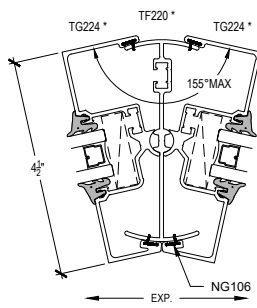

180-155° FLEXIBLE CORNER ASSEMBLY

6-7

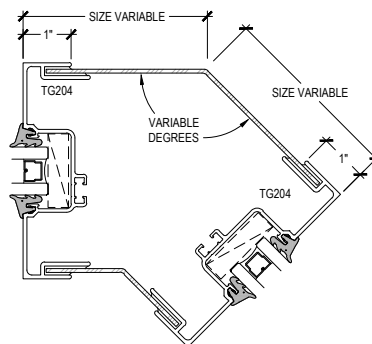

FLEXIBLE CORNER ASSEMBLY

6-8

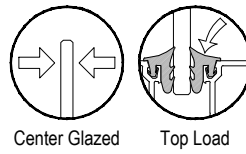

# AG451 Series

Description: 2" x 4 1/2" Center Glazed for 1" Glass

Function: Storefront

Detail: Doors

Scale: 3" = 1'-0"

SHEET 5 OF 5

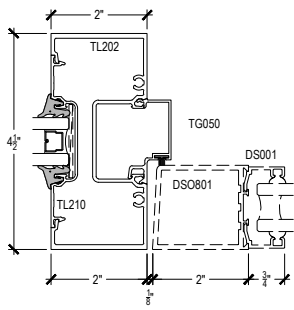

DOOR JAMB @ OFFSET HUNG

7-1

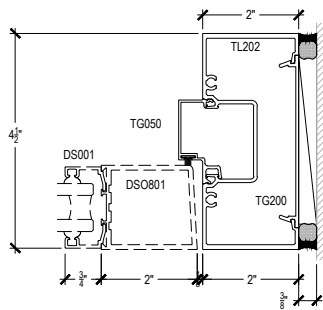

DOOR JAMB @ OFFSET HUNG

7-2

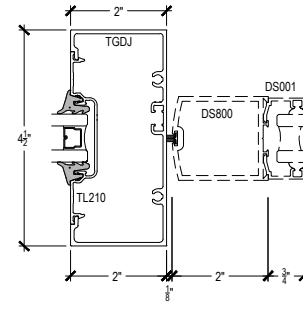

DOOR JAMB @ CENTER HUNG

8-3

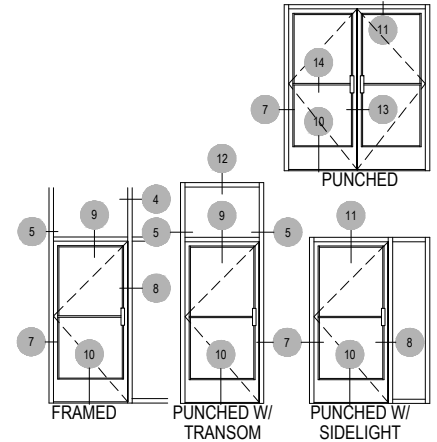

PUNCHED

FRAMED

PUNCHED W/ TRANSOM

PUNCHED W/ SIDELIGHT

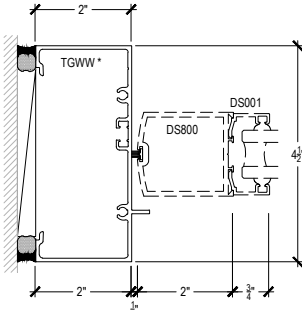

DOOR JAMB @ CENTER HUNG

7-3

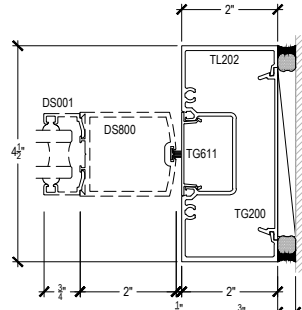

DOOR JAMB @ CENTER HUNG

7-4

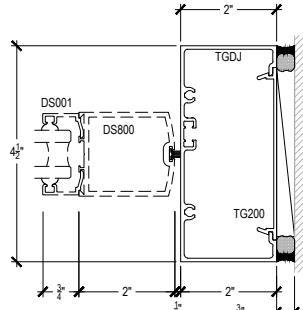

DOOR JAMB @ CENTER HUNG

7-5

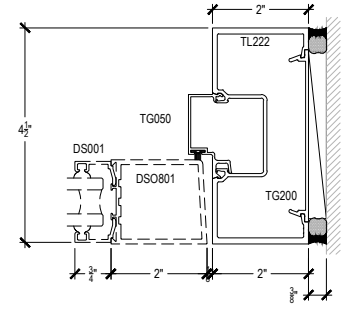

DOOR JAMB @ OFFSET HUNG

7-6

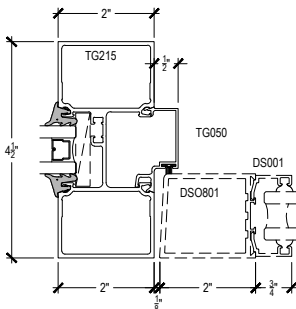

DOOR JAMB @ OFFSET HUNG

8-1

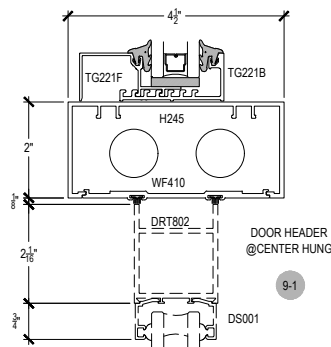

DOOR HEADER @ CENTER HUNG

9-1

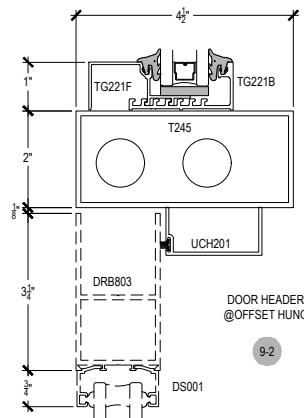

DOOR HEADER @ OFFSET HUNG

9-2

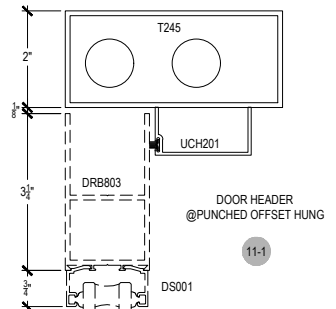

DOOR HEADER @ PUNCHED OFFSET HUNG

11-1

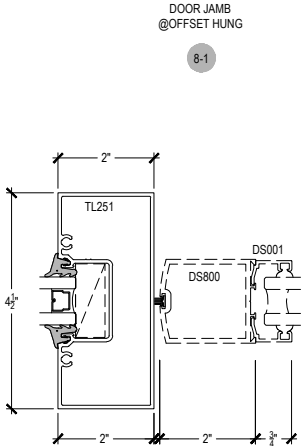

DOOR JAMB @ CENTER HUNG

8-2

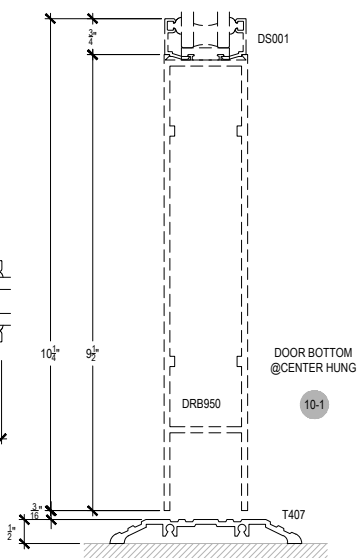

DOOR BOTTOM @ CENTER HUNG

10-1

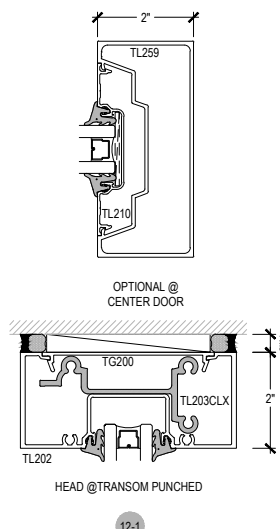

HEAD @ TRANSOM PUNCHED

12-1

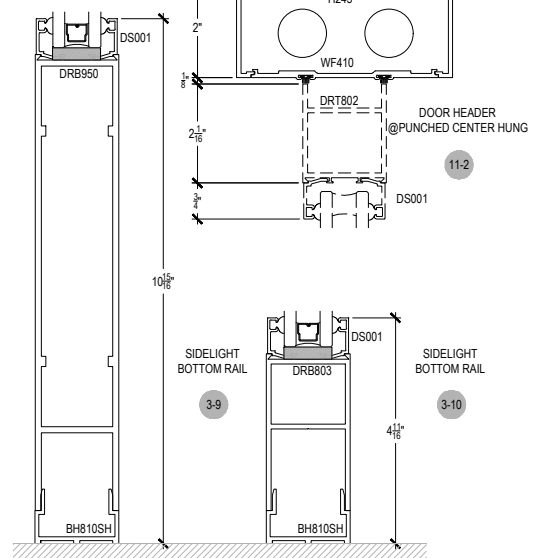

DOOR HEADER @ PUNCHED CENTER HUNG

11-2

SIDELIGHT BOTTOM RAIL

3-9

SIDELIGHT BOTTOM RAIL

3-10