

AFG451T Series

Description: 2" X 4 1/2" Offset Glazed For 1" Glass

Function: Storefront

Detail: Horizontals

Scale: 3" = 1'0"

SHEET 1 OF 6

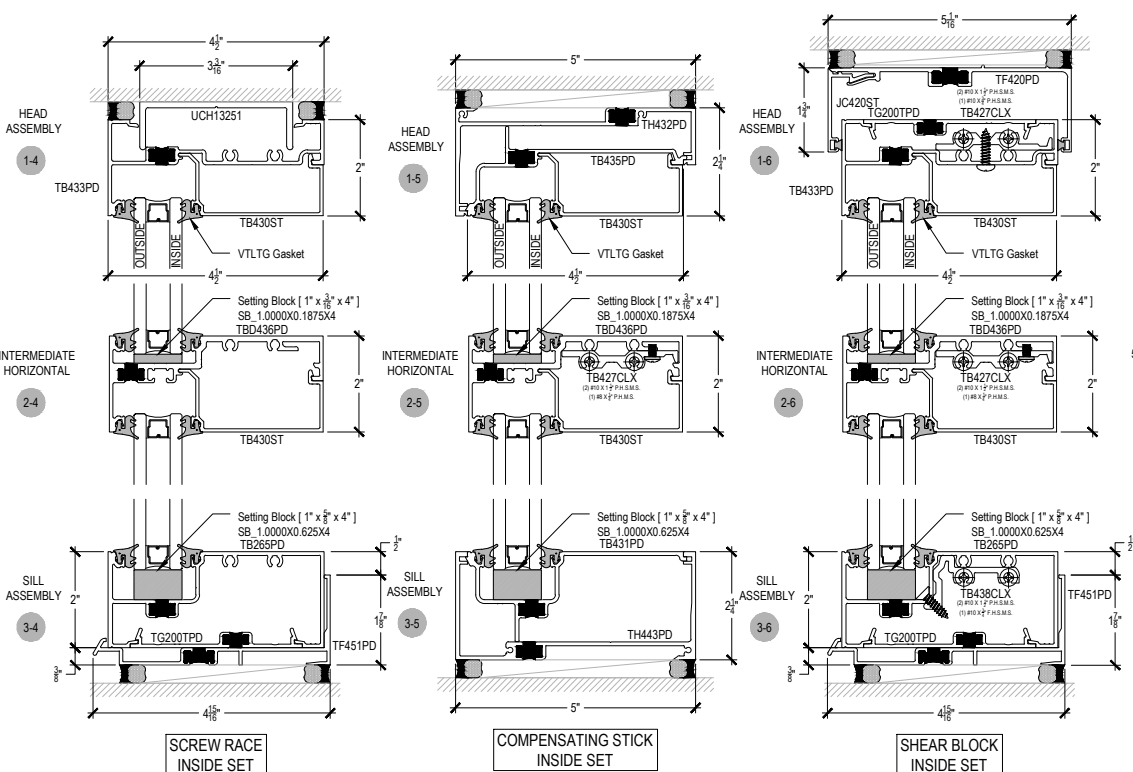
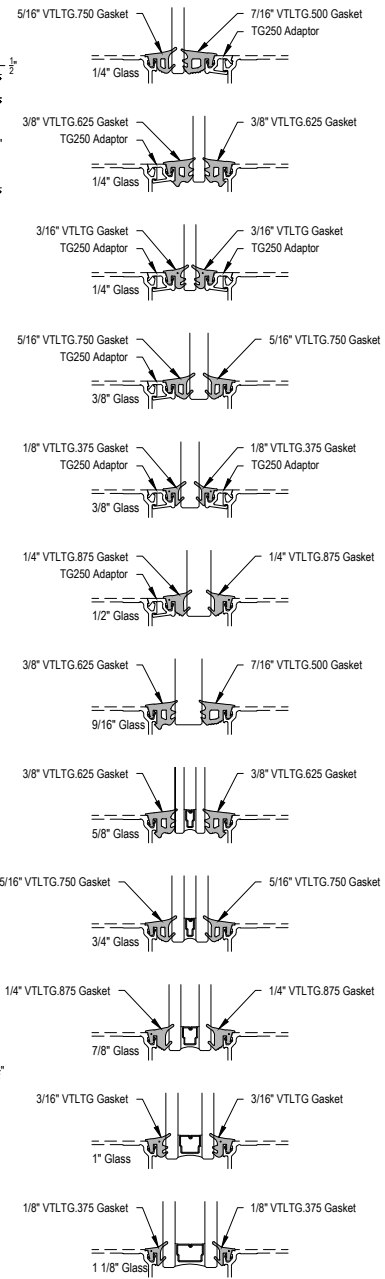
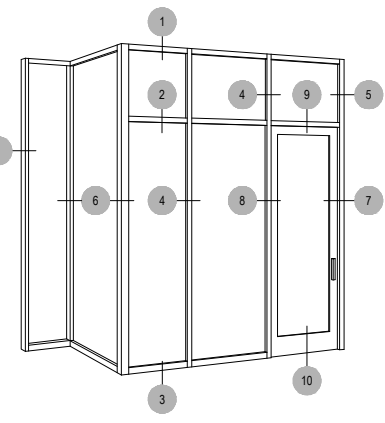
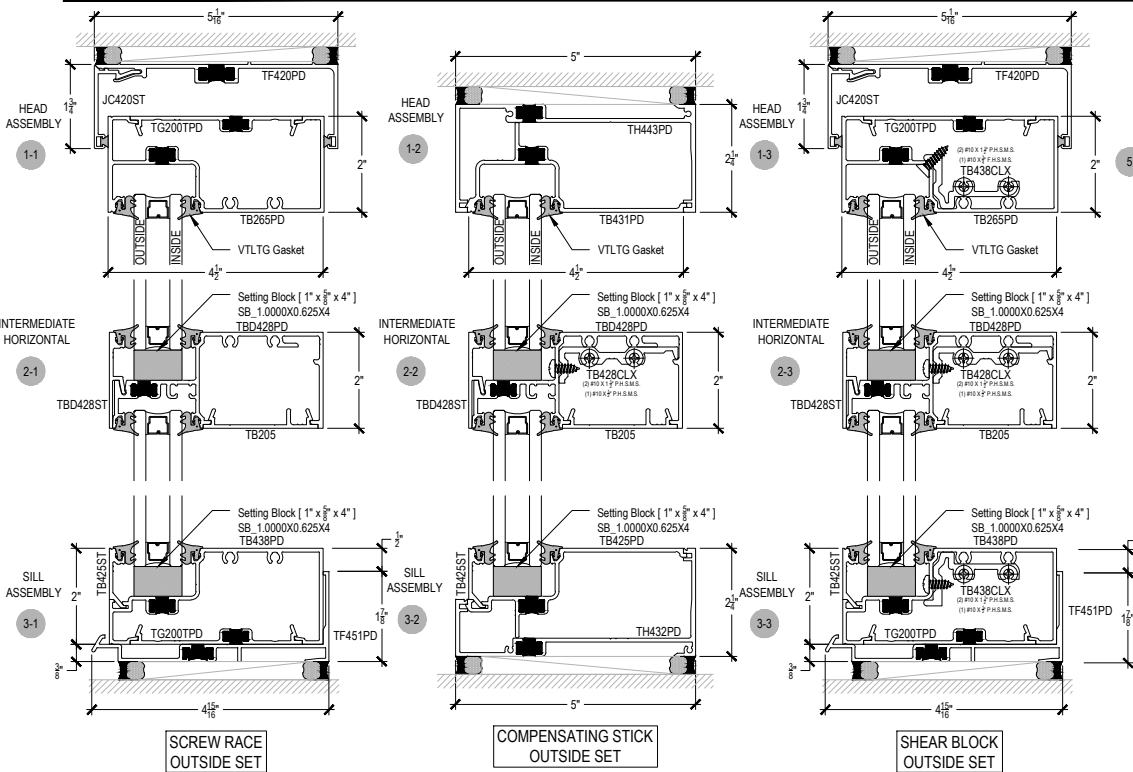

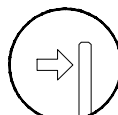

Offset Glazed

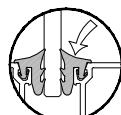

Top Load

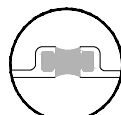

Thermal System

AFG451T Series

Description: 2" X 4 1/2" Offset Glazed For 1" Glass

Function: Storefront

Detail: Horizontals

Scale: 3" = 1'0"

SHEET 2 OF 6

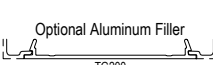
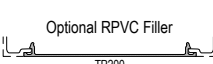
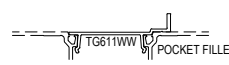
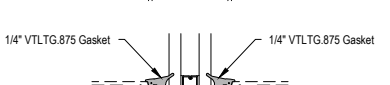
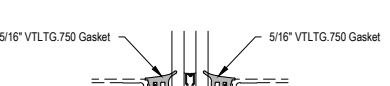
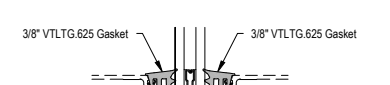
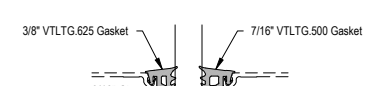
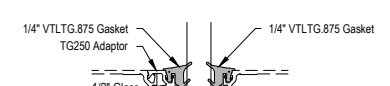
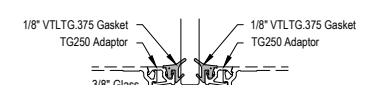
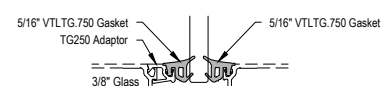
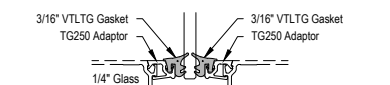
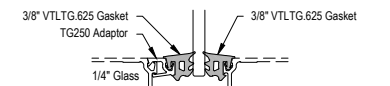
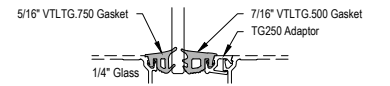
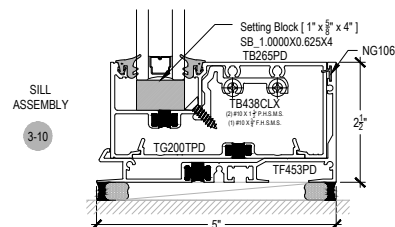
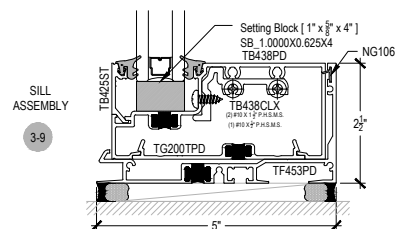
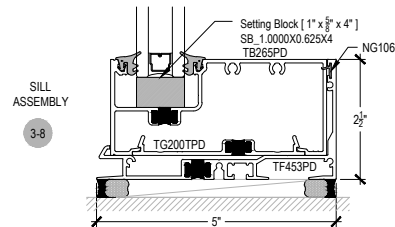
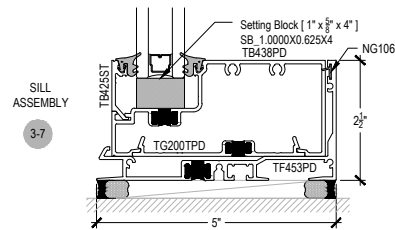
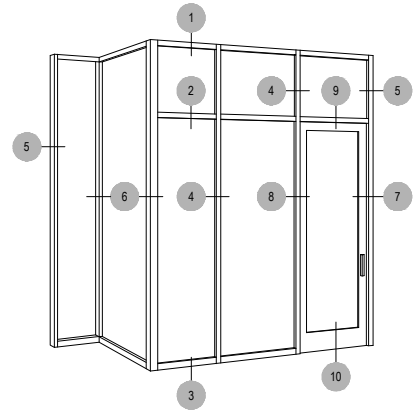
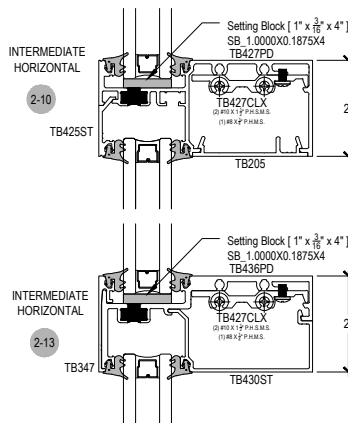
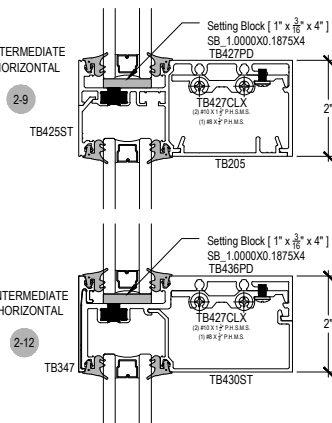
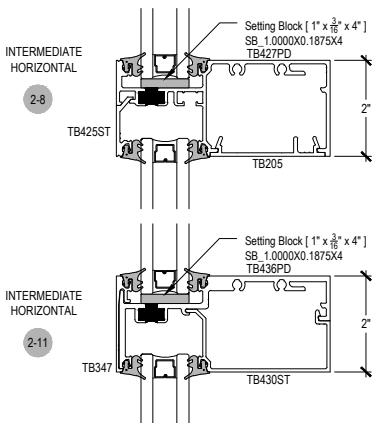

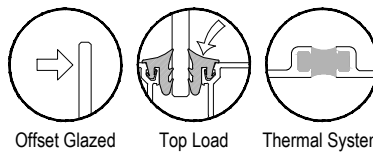

AFG451T Series

Description: 2" X 4 1/2" Offset Glazed For 1" Glass

Function: Storefront

Detail: Verticals

Scale: 3" = 1'0"

SHEET 3 OF 6

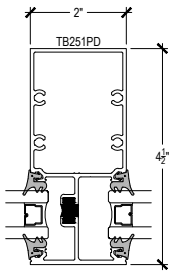

INTERMEDIATE VERTICAL

4-1

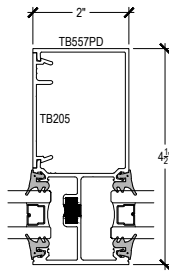

INTERMEDIATE VERTICAL

4-2

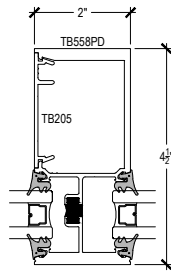

INTERMEDIATE VERTICAL

4-3

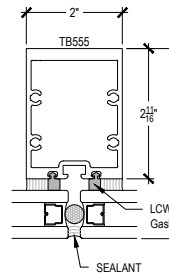

INTERMEDIATE VERTICAL

4-4

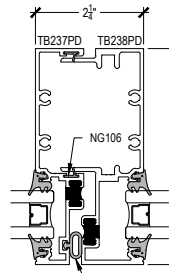

MALE/FEMALE EXPANSION INTERMEDIATE VERTICAL

4-7

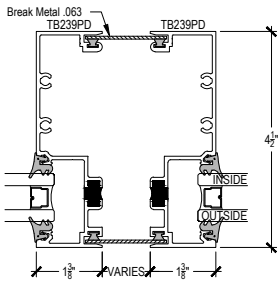
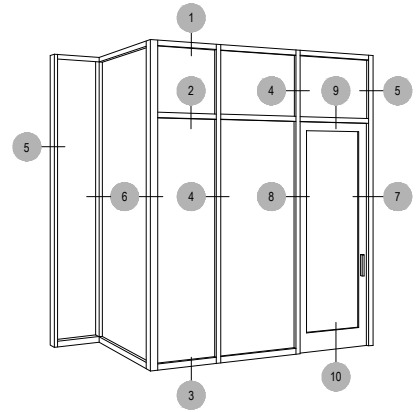

EXPANSION INTERMEDIATE VERTICAL

4-8

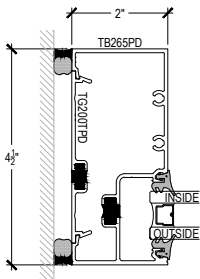

WALL JAMB

5-1

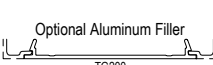
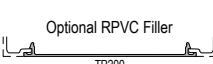
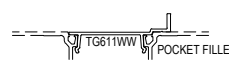
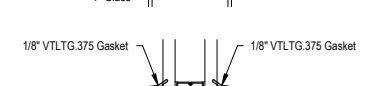
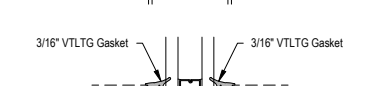
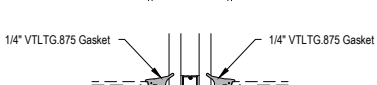
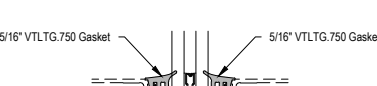
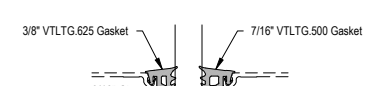
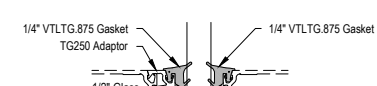
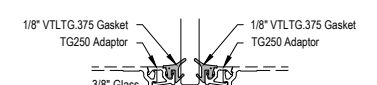
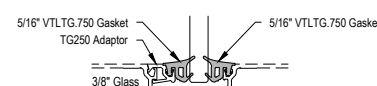
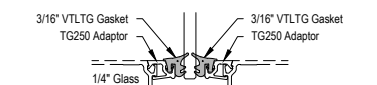
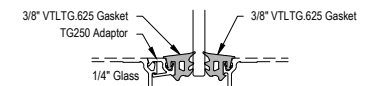
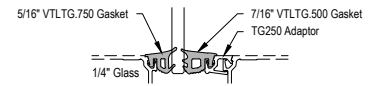

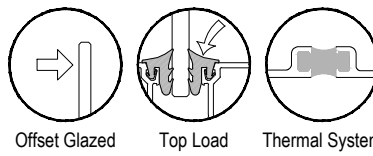

AFG451T Series

Description: 2" X 4 1/2" Offset Glazed For 1" Glass
 Function: Storefront
 Detail: Corners
 Scale: 3" = 1'0"

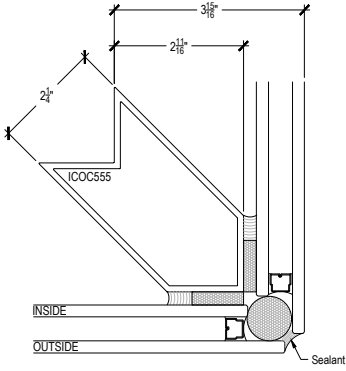

90° OUTSIDE CORNER
6-1

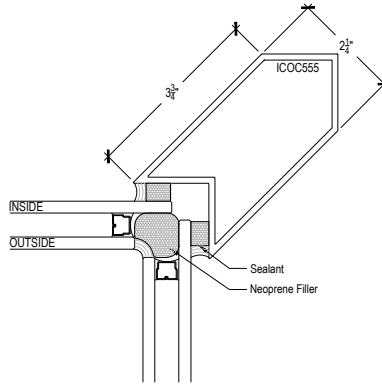

90° INSIDE CORNER
6-2

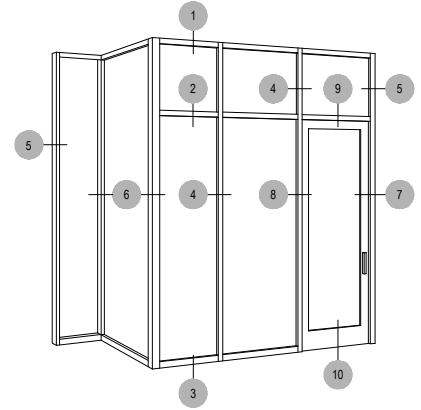

90° CORNER ASSEMBLY
6-3

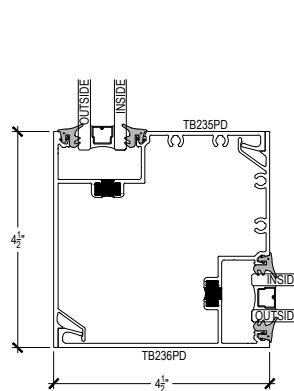

90° CORNER ASSEMBLY
6-4

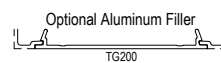
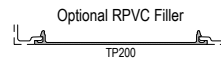
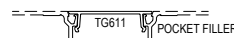
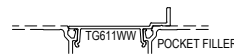
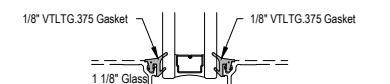
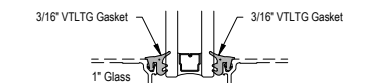
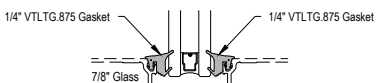
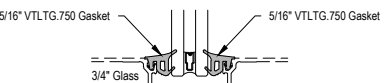
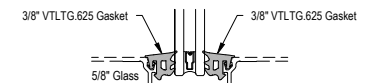
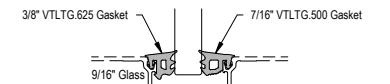
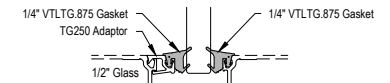
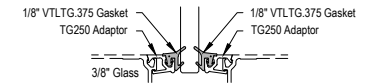
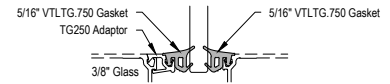
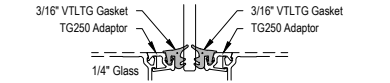
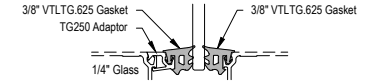
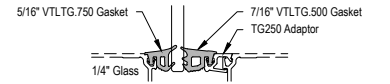

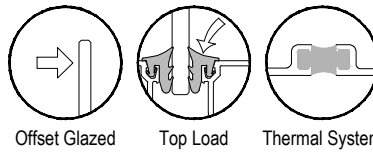

AFG451T Series

Description: 2" X 4 1/2" Offset Glazed For 1" Glass

Function: Storefront

Detail: Offset Hung Doors

Scale: 3" = 1'0"

SHEET 5 OF 6

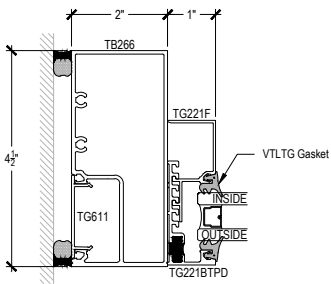

5-3

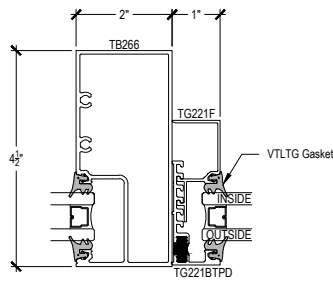

4-6

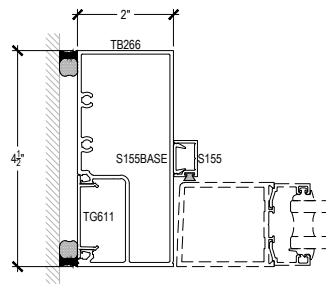

7-1

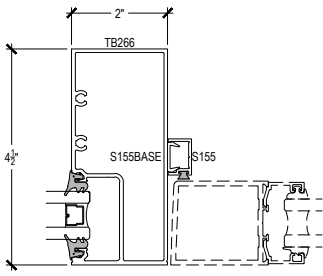
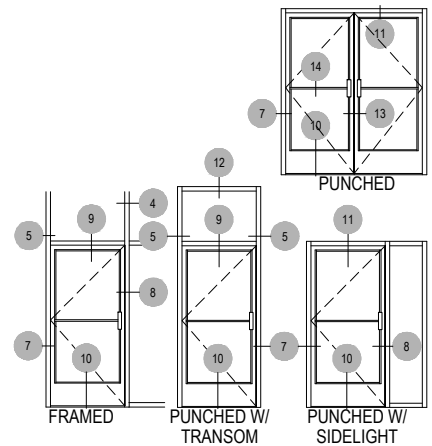

8-1

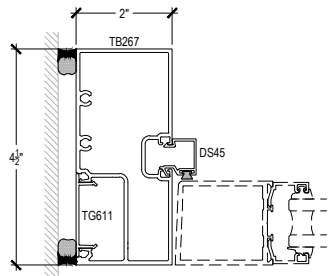

7-3

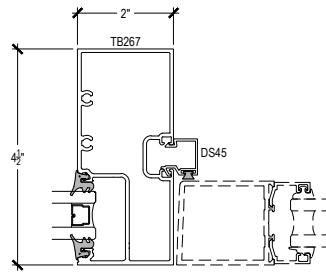

8-3

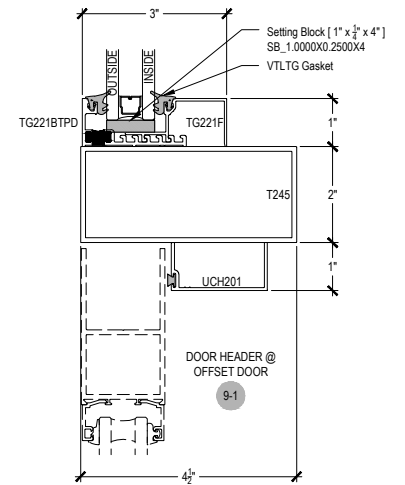

9-1

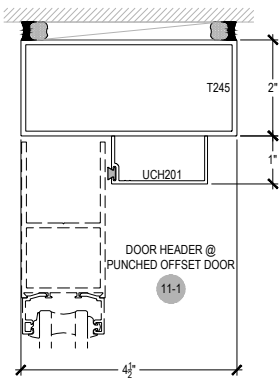

11-1

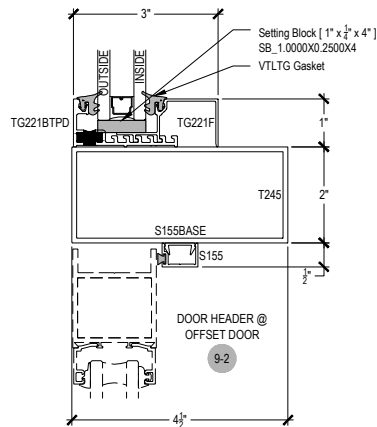

9-2

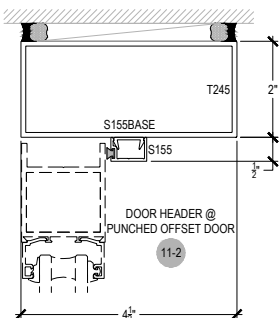

11-2

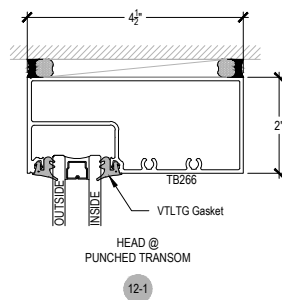

12-1

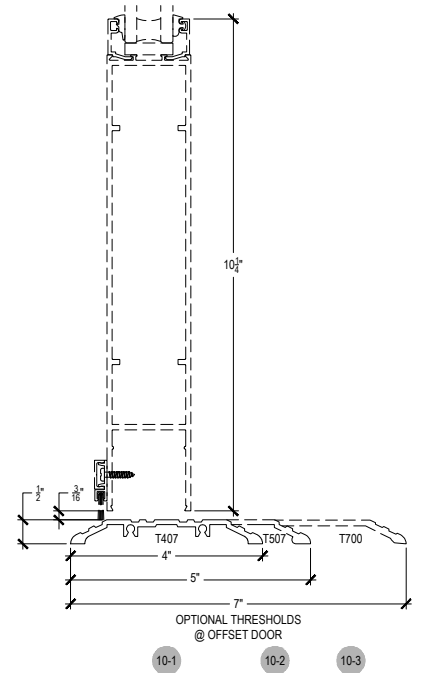

10-1 10-2 10-3

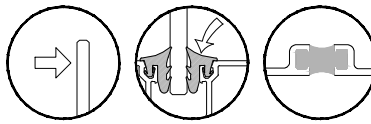

Offset Glazed

Top Load

Thermal System

AFG451T Series

Description: 2" X 4 1/2" Offset Glazed For 1" Glass

Function: Storefront

Detail: Center Hung Doors

Scale: 3" = 1'0"

SHEET 6 OF 6

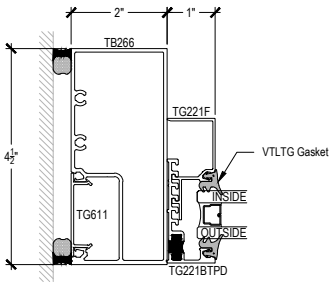

OPTIONAL JAMB @ TRANSOM

5-3

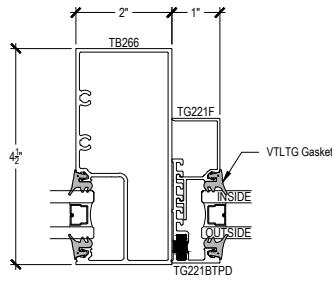

OPTIONAL JAMB @ TRANSOM

4-6

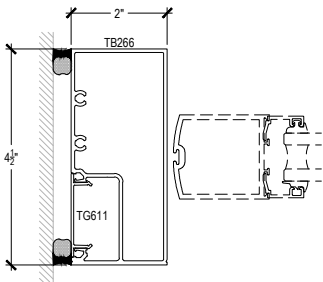

DOOR JAMB @ CENTER DOOR

7-2

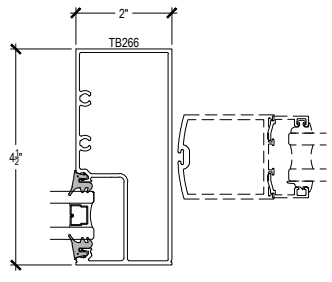

DOOR JAMB @ CENTER DOOR

8-2

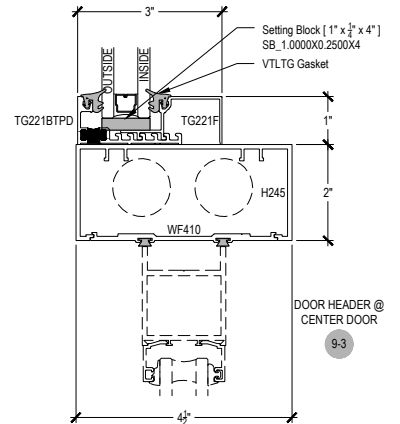
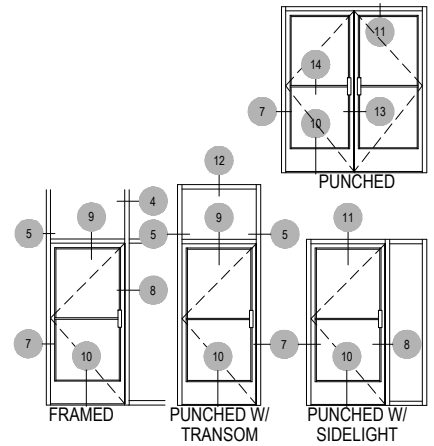

DOOR HEADER @ CENTER DOOR

9-3

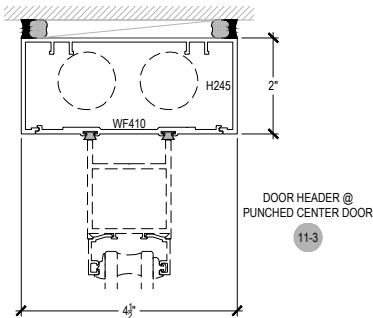

DOOR HEADER @ PUNCHED CENTER DOOR

11-3

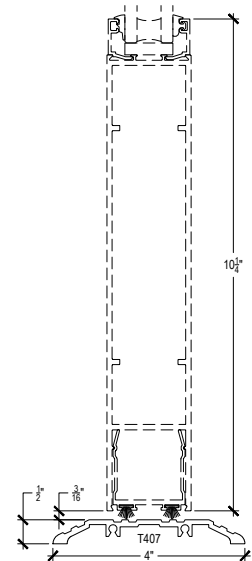

THRESHOLD @ CENTER DOOR

10-4